

HH950

Operating Instructions

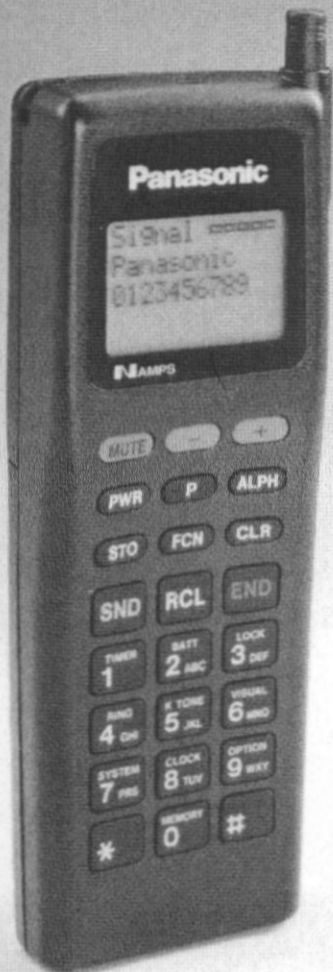

HH950 PERSONAL
CELLULAR TELEPHONE

NAMPS system compatible

Panasonic®

Before operating this set, please read these instructions completely.
Charge the battery before operation.

102X01601

Serial numbers appear on the outside of the Handset For future reference, record these numbers here in this table and retain the manual to serve as a permanent record of your purchase

HANDSET

Model Number EB-3533

Serial Number _____

DEALER NAME _____

PURCHASE DATE _____

Panasonic*

HH950

Personal Cellular Phone

Operating Instructions

**©1993 by Matsushita Communication Industrial Co., LTD
All Rights Reserved. Published 1993
Printed in the USA**

102X01601

Table of Contents

CHAPTER 1 INTRODUCTION

Features	1-2
Kit Composition	1-5
Accessories	1-6
Other Accessories	1-9
Items To Note Before Operating	1-10
Terms	1-14

CHAPTER 2 ABOUT THE HANDSET

Keys and Indicators	2-1
Battery Pack Information	2-3
How to Install/Remove the Battery Pack	2-4
Charging Procedures	2-5
How to Extend/Retract the Antenna	2-9
Attaching the Carrying Strap	2-10
Cleaning	2-11

CHAPTER 3 OPERATION

Powering On	3-1
How To Make A Call	3-3
Auto Retry	3-4
Automatic Redial	3-4
Indicator Tones (with Unsuccessful Calls)	3-5

CONTENTS

How To Receive A Call	3-6
Powering Off	3-8
Additional Operations	3-9
Adjusting the Earpiece/Keytone Volume	3-9
Received Call Indicator	3-10
Mute	3-11
Hold	3-11
Dual Tone Multi-Frequency (DTMF)	3-12
DTMF Interval	3-12
Flash Request	3-13
How To Enter Alphanumeric Characters	3-14
Entering Letters/Numbers	3-14
Word List	3-17
Speed-Dial Memory	3-19
How to Store Using Speed Dial	3-19
Storing by Memory Location Number	3-20
Auto Memory Location	3-21
Memory Map	3-22
Override Protection	3-23
Storing by Name Tag	3-23
Storing by Group Label	3-25
Using Recall	3-27
Recalling by Memory Location Number	3-28
Super-Speed Dialing	3-29
Recalling by Name Tag	3-30
Recalling by Group Label	3-31
Speed-Dial Memory Edit	3-33
Changing Memory Contents	3-33
Deleting Memory Contents	3-35
Last Number Memory	3-36
Scratch Pad Memory	3-37
Caller's Memory	3-38
DTMF From Memory	3-38
Prefixed Dialing	3-39

CONTENTS

Pause Dial	3-41
How to Program and Use Pause Dial	3-42
Function Key Operation	3-44
Using the Function Guide	3-44
Enhanced Features (Cellular System Optional)	3-46
Call-Back Number	3-46
Short Messages	3-48
Voice Mail Notification	3-49
Call Length Timer (FCN 1)	3-52
Battery (FCN 2)	3-54
Battery Level Indicator (Handheld Use Only)	3-54
Pace Beep	3-55
Low Battery Alarm	3-56
Security (FCN 3)	3-57
Lock	3-57
Dialing Digits Restriction	3-58
Memory Secret	3-60
Theft Lock	3-61
Master Function	3-63
How to Set Theft Code	3-66
How to Set New Lock Code	3-67
Ringing (FCN 4)	3-68
Ring Volume Control	3-68
Setting Ring Tone	3-69
Escalating Ring Tone (Handheld Use Only)	3-70
Auto Answer (Car Mount Use Only)	3-71
Keytones On/Off (FCN 5)	3-72
Display (FCN 6)	3-73
Wake-up Display Program	3-73
Backlight Control (Car Mount/DC Adaptor Use Only)	3-74
Setting Backlight Color	3-75
System (FCN 7)	3-76
Own Number Display	3-76
A/B System Select	3-77
Clock (FCN 8)	3-80
Setting the Clock	3-80
Automatic Recall (Handheld Use Only)	3-82
Auto Power On (Alarm)	3-84
Auto Power Off (Handheld Use Only)	3-86
Safety Timer (Car Mount Use Only)	3-88
Vehicle Use Options (FCN 9)	3-89
Call Receive	3-89

CONTENTS

Alert Option	3-91
Radio Mute Option	3-92
Memory (FCN 0)	3-93
Memory Check	3-93
Creating/Deleting Group Label Program	3-94

APPENDIX A STORING NAMES & NUMBERS

APPENDIX B SPEED DIAL MEMORY INDEX

INDEX

Introduction

1

Congratulations on the purchase of your new HH950 Handheld Portable Cellular Telephone! This manual describes how to operate all standard and enhanced features of your phone.

Please read this manual carefully before attempting to use your phone. For information on available accessories, please refer to the appropriate accessories' Operating Instructions Manual.



HH950 Handheld Portable Telephone

Features

General

- "Any key" answer (except **PWR** and **END** keys)
- Auto Answer; answers calls automatically after 6 seconds (handsfree/car mount only)
- Prefixed Dialing; store & recall commonly used number prefixes (up to 32 digits)
- Backlit keypad and liquid crystal display (LCD); with automatic shut-off when sensing no keypad activity after seven seconds (saves battery power)
- Last digit/All digit clear
- Silent keypad
- Clock; shows current time and date
- Multi-stepping earpiece volume control
- Retractable one-piece antenna
- Mouthpiece mute function for private conversation while still connected to a call
- Hold Function; mutes both the handset microphone and earpiece
- 832-channels std. operation; 2,412 NAMPs channels
- DTMF (Touch Tone) signaling and Flash request

Memory

- 200 total memory slot capacity
- 48-digit, 16-character capacity per memory location
- Vacant Memory Location Search; allows locating the next available memory slot.
- Memory Check; allows verifying the amount of memory capacity presently used, or the number of items currently stored in all memory slot locations
- Memory Map Review; shows available memory locations
- Override Protection; protects against accidentally storing new information over occupied memory location slots
- Auto Memory Location; automatically selects the smallest vacant memory location for storing data
- Scratch Pad; allows entering a number for later reference, while conversing
- Scratch Pad Recall
- Pause Dial; allows transmitting a sequence of numbers stored in a single memory slot for functions outside the cellular network such as long distance access codes and voice mail retrieval
- Group Label Memory; allows arranging stored information into individual groups (up to 30) by assigning 12-digit character labels
- Super Speed Dialing
- Selectable Memory Recall by:
 - memory location #
 - first letter of tag name
 - group label name
 - super speed dialing
 - list of last ten calls
 - Caller's Memory feature

Memory (cont.)

- Word List; contains a listing of predefined, commonly-used words to simplify creating/editing Group Labels and Name Tags.
- Last number memory and redial; ten most recently-called numbers are automatically stored in memory with a time/date stamp
- Auto Retry; phone redials the same number automatically every ten seconds (up to 15 times) after the re-order tone, i.e., the system is busy
- Auto-Power On; powers the phone ON automatically at a pre-selected time.
- Auto-Power Off; powers the phone OFF automatically at a pre-selected time.
- DTMF Signaling from Memory; provides access to data systems

Display/Indication:

- Signal Strength Indicator; shows the strength of the received system service.
- 16-character/4-line alphanumeric Liquid Crystal Display (LCD)
- Own number recall display
- Visual and audible low battery warning indicator
- Received Call Indicator; shows the number of calls (up to 99) you've received but not answered along with a time/date stamp of the 10 most recent calls
- Silent Alert; ringing tone is muted while display shows ringing message
- Overflow character display
- Audible pace beep every minute to help track length of calls
- Programmable Wake-up Display Message

Selectable:

- Ringing; select volume, tone, and escalating volume/tone
- Four-level electronic lock:
 - Full: locks all incoming and outgoing calls
 - Dial: transmits only stored numbers
 - Send: can only receive calls
 - Receive: can only make calls
- Dual-selectable telephone number
- Total elapsed timer (for two different numbers)
- Resettable total call length timer
- Non-resettable total call length timer
- Separate, non-resettable total timer for each of two numbers
- Individual call length timer
- Last Call Timer
- Auto Recall; phone reminds user to call a specified # at preselected time

Selectable (cont.):

- Security
 - Emergency call enable (dealer-programmable)
 - Unlock Code (user programmable)
 - Memory Secret, selectable between no access, full access, and read only
 - Theft Alarm, unauthorized phone use sounds the vehicle horn (requires optional Alert Kit J10262)
- Wireline/Non-wireline system selection
- Roam inhibit of calls to prevent unauthorized use
- Dialed digits restriction to prevent unauthorized long distance calls

Available:

- Rapid Charger Kit (EB-911), 2 slots for rapid charging (see page 1-6)
- DC Adapter Kit (EB-912), Allows powering phone from the vehicle cigarette lighter outlet (see page 1-6)
- Handsfree Car Mount Kit (EB-905), converts Model HH950 from handheld use to handsfree car mount use (see page 1-7)
- In-Cabin Booster Kit (EB-910), provides 3-watt booster unit for vehicle in-passenger compartment mounting
- In-Trunk Booster Kit (EB-910A), provides 3-watt booster unit for vehicle in-trunk mounting (includes extension cabling)
- Battery (500mAH)
- Battery (900mAH)
- Horn Alert for mobile use (EB-J10262 Alert Kit required)

Enhanced (cellular system optional):

- Call-Back Number, provides a digital page and convenient call back (in conjunction with the cellular system provider)
- Short Messages, allows access to messages received from cellular service provider
- Voice Mail Notification, shows number of voice mail messages received by the voice mail service provider

Kit Composition

Handset Kit HH950:

CONTENTS	PART NUMBER
• Handset	EB-3533
• Travel Charger	EB-P10150
• Battery Pack (500 mAH)	EB-P10180
• Carrying Strap	EB-B10023
• Connector Cap	EB-Y10079
• Operating Instructions	102X01601
• Quick-Reference Card	102X01701
• Warranty Card	102X03501
• Packing	

HANDSET

STRAP

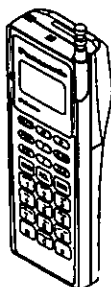

BATTERY PACK
(500 mAh)



TRAVEL
CHARGER

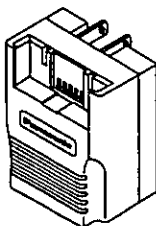

Accessories

The following tables/figures describe the standard and available accessories to further enhance the operation of your phone. See your Panasonic dealer for details.

Rapid Charger Kit EB-911:

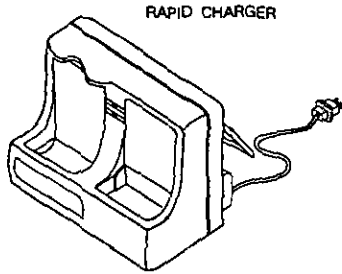

CONTENTS	PART NUMBER
<ul style="list-style-type: none"> • Rapid Charger • Operating Instructions • Warranty Card • Packing 	EB-P10151 ZD10460 ZD10205

DC Adapter Kit EB-912

CONTENTS	PART NUMBER
<ul style="list-style-type: none"> • DC Adapter • Cradle • Adj. Angle Bracket • Operating Instructions • Warranty Card • Packing 	EB-P10151 EB-J10138 EB-N0001C ZD10461 ZD10205

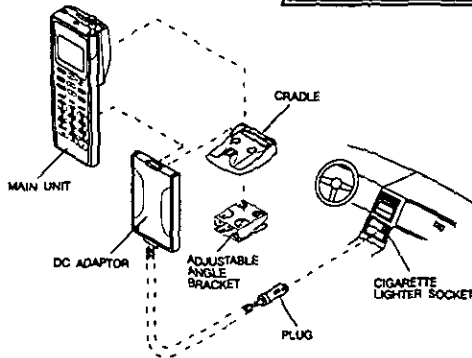

Handsfree/Car Mount Kit EB-905:

CONTENTS	PART NUMBER
• Handsfree Unit/Rapid Charger Cradle	EB-J10139
• Adj Angle Bracket	EB-N0001C
• Power Supply Cable - 12'	EB-W10030
• Operating Instructions	ZD10463
• Warranty Card	ZD10205
• Packing	

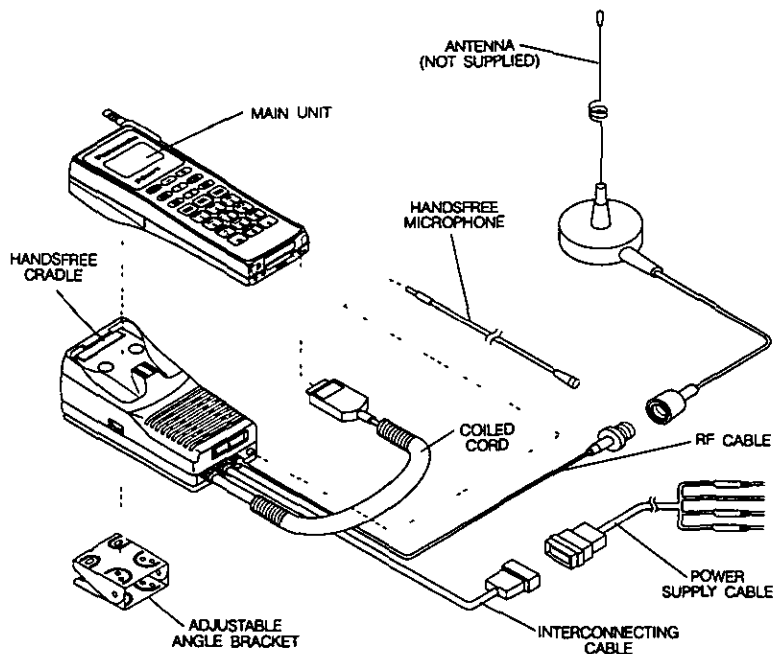

In-Cabin Booster Kit EB-910:

CONTENTS	PART NUMBER
<ul style="list-style-type: none"> • Booster • Operating Instructions • Warranty Card • Packing 	EB-U10022 ZD10464 ZD10205

In-Trunk Booster Kit EB-910A:

CONTENTS	PART NUMBER
<ul style="list-style-type: none"> • Booster • Extension Interconnect Cable - 17' • Extension RF Cable - 17' • Extension Power Supply Cable - 17' • Operating Instructions • Warranty Card • Packing 	EB-U10022 EB-W10034 EB-W10035 EB-W10036 ZD10465 ZD10205

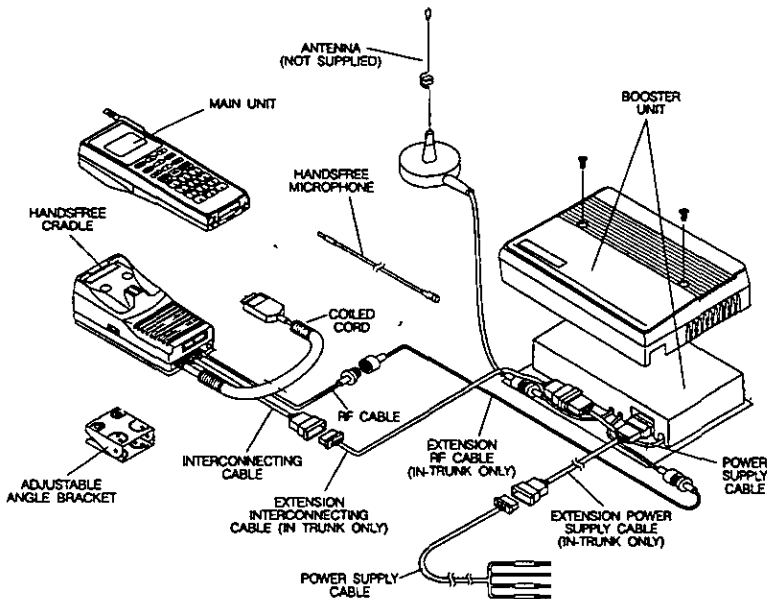

Other Accessories:

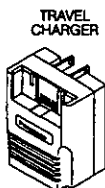

BATTERY PACK
(500 mAh)



BATTERY PACK
(900 mAh)



CONTENTS	PART NUMBER
• Battery Pack (500mAh/Ni-MH)	EB-P10180
• Battery Pack (900mAh Ni-Cd)	EB-P10149
• Travel Charger	EB-P10150
• Ext Pwr Supply Cable (12')	EB-W10033
• Ext Pwr Supply Cable (17')	EB-W10034
• Ext Interconnect Cable (17')	EB-W10035
• Ext RF Cable (17')	EB-W10036
• Alert Unit	EB-J10262

Items to Note Before Operating

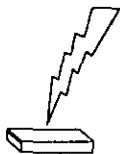

- Fully charge the battery before attempting to use your phone (see page 2-5 for charging procedures).



- This unit meets or exceeds current safety standards with respect to human exposure to electromagnetic fields (see American National Standard, ANSI C95.1-1982). However, it is recommended while using the phone, that the user should avoid touching the antenna to exposed parts of the body (particularly eyes and face). In handsfree/car mount use, do not operate the phone if you or another person is within 8 inches (20cm) of the vehicle antenna.

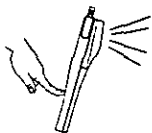

- Pressing any key on the keypad may cause a loud tone from the handset speaker. Be sure the handset is away from your ear before pressing any keys.



- Speed-Dial memory and clock memory may be corrupted or lost if your phone is without power for approximately 30 days.

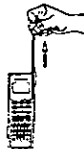

- Before making or receiving calls, fully extend the antenna.



- The liquid crystal display on your phone may slightly change color, or take somewhat longer than usual to display characters in extremely high or low temperatures. This is normal and does not indicate a defective display.

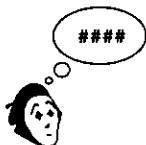

- To prevent your phone from unauthorized use, memorize your theft and lock codes. If you lose your lock code, contact your Panasonic or phone dealer for assistance.

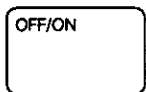

- If after powering ON your phone, the display shows the message **OFF/ON**, switch the power OFF and then ON again. Please contact your dealer if **OFF/ON** message does not disappear.

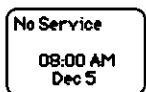

- If the display shows the message **No Service**, you have moved outside the service coverage area. Move into a different location until **No Service** message disappears.

NOTE: *If your phone operates with two phone numbers, check that the phone number you're trying to use is the proper number for the network in your current location.*

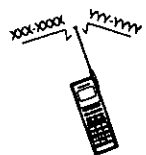

- If you have two phone numbers, you may only receive calls for the number currently selected on your phone.



- Never store flammable liquids, gases, or explosive materials in the same area as your phone.



- Do not use your phone within an aircraft. Using cellular telephones in an aircraft is dangerous to the operation of the aircraft, may disrupt the cellular telephone network, and is illegal. Failing to observe this restriction may lead to suspension or denial of cellular telephone service, legal action, or both.



- Acquaint yourself with the special guidelines from the Highway Code for your state regarding the use of mobile radios, including cellular telephones, while operating a motor vehicle.

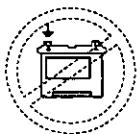

- Do not install or connect your phone in a vehicle which uses a positive (+) grounding system. Use negative (-) grounding only.
- Always disconnect the phone before attempting to jump start your vehicle.



- Power off your phone when potentially explosive conditions exist, such as when refueling, or any place where a sign is posted restricting the use of two-way radio equipment such as construction sites, blasting areas, etc.

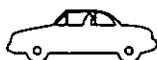

- Electronic fuel injection, anti-skid brakes, and speed control systems (cruise control), and similar type electronic devices might malfunction if your car lacks adequate isolation from RF (radio frequency) signals. If your car has any of these type devices, contact your dealer for assistance in determining whether such systems perform normally when your phone is transmitting.



- Do not store or transport battery packs with metallic items such as keys, coins, etc. Damage to the items, as well as personal injury may occur should they accidentally make contact with the battery pack.



- For service, call your local Panasonic dealer, or to locate the nearest authorized Panasonic Service Center call 1-800-526-6610.



DON'TS

DON'T use this equipment in an extreme environment where high temperature or high humidity exists.

DON'T attempt to disassemble this equipment. No user-serviceable parts exist inside.

DON'T abuse this equipment. Avoid striking, shaking, or holding it by antenna.

DON'T expose the handset to water, or spill beverages on it.



DO'S

DO use the equipment under conditions where temperatures are within the -4°F to +140°F (-20°C to +60°C) in car mount use and within 14°F to 104°F (-10°C to +40°C) in transportable use.

DO refer any servicing to qualified service personnel.

DO handle this equipment with care.

DO take immediate action if the equipment becomes wet. Turn power off and refer servicing to qualified personnel.

Terms

NAMPS:

Narrow-Band AMPS. A high-capacity cellular technology which operates on 2,412 channels, as opposed to 832 channels on standard AMPS systems.

Carrier:

This is the cellular service provider. The carrier can be associated with your local telephone company or an independent company.

Home Carrier:

The system to which your dealer registers your phone.

Roaming:

Using your cellular phone on any carrier to which it is not registered.

Automatic Roaming (ROAM):

If a carrier in a city which you are visiting has an agreement with your home system, bills are charged to your account in your home system automatically.

Credit Card Roaming (ROAM):

If the system in which you are roaming does not have automatic roaming, you can use your credit card for billing purposes.

Follow-Me Roaming:

An available service which allows your calls to "follow" you to the city in which you are roaming. This means calls made to your seven digit local mobile number are automatically forwarded to the city where you are presently traveling.

Wireline Carrier (W/L):

Your local telephone company.

Non-Wireline Carrier (N-W/L):

The cellular company in an area which is not associated with the local telephone company.

About the Handset

2

Keys and Indicators

Controlling the many Model HH950 operating features is performed using the handset keys and display. This section provides a quick-look at these features. For detailed operating instructions, see Chapter 3 Operation.

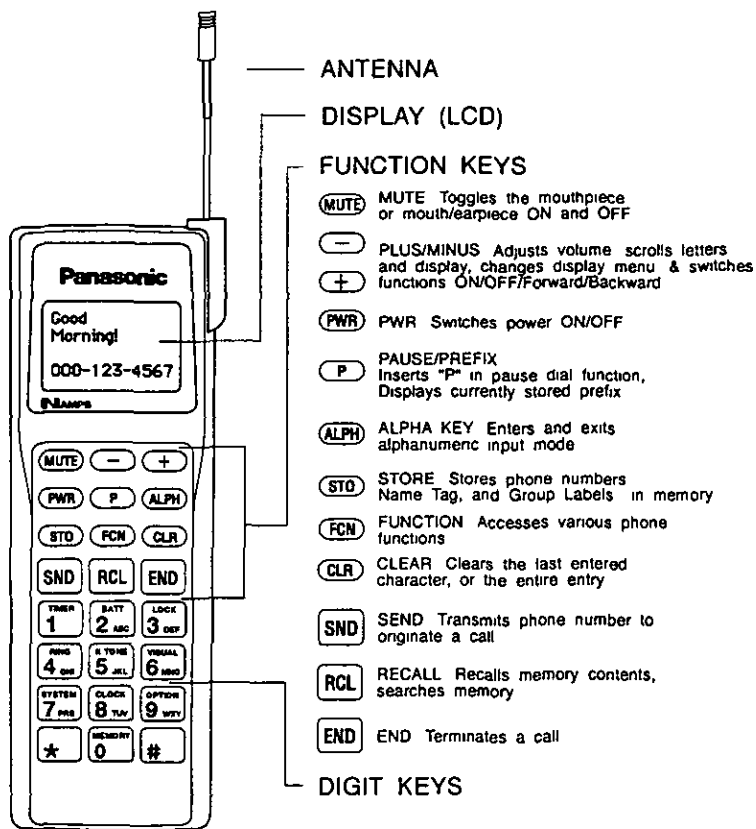

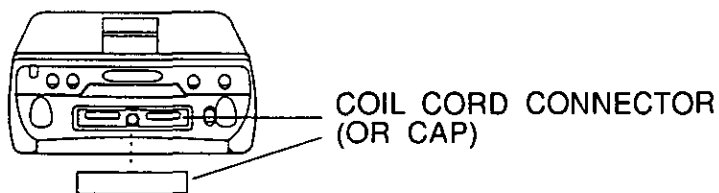
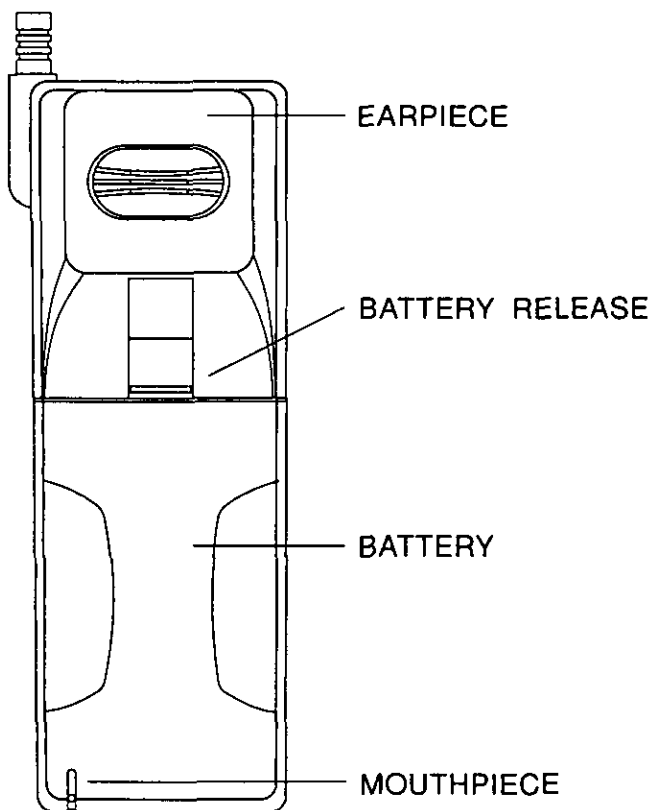
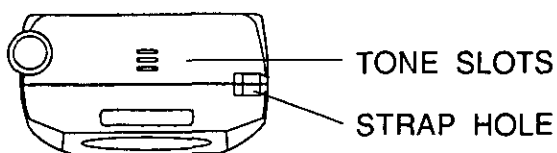

Battery Pack Information

Observe the following precautions with your battery pack:



Ni-Cd

- **Attention:** This product uses a battery that can be recycled. Under some state and local laws, it is illegal to discard the battery into the municipal waste. Check with your local solid waste officials for recycling or disposal information.

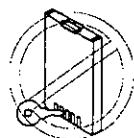

- Do not short the battery contacts.

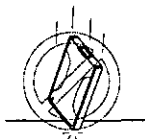

- Avoid dropping or subjecting the battery to strong physical shocks.

- Repeatedly using the battery for short periods followed by frequent charging reduces the battery's charging capacity. Instead, continue using the battery until the phone shuts itself OFF.

- If battery charging capacity has deteriorated through such use, it may be regained by using it until the phone shuts off automatically, and then fully charging the battery. Repeat this step several times.

- If using a fully recharged battery and the LOW BATTERY WARNING tone sounds, contact your Panasonic Service Center or replace your battery.

Low Battery
Charge
Your
Battery!

- If you do not anticipate using the handset for long periods, remove the battery from the handset and fully recharge the battery at least once a month.

JUNE						
5	6	7	8	9	10	11
12	13	14	15	16	17	18
19	20	21	22	23	24	25
26	27	28	29	30		

- Standby Time/Talk Time (typical)

Time Condition	Duration (approx.) by Battery Type	
	500mAh Nickel-Metal Hydride	900mAh Nickel-Cadmium (optional)
Stand-By	10 hours	20 hours
Talk Mode	80 minutes	160 minutes

How to Install/Remove the Battery Pack

To install the battery pack, perform the following steps

- 1 Place the handset face-down on a soft, protective surface to avoid accidentally scratching the display window
- 2 Insert the battery into the back of the handset, aligning the bottom tab of battery with the lower slot of handset case
3. Gently press the battery in place until you hear it "click" into place
- 4 Make sure the battery release is in the lock or "up" position

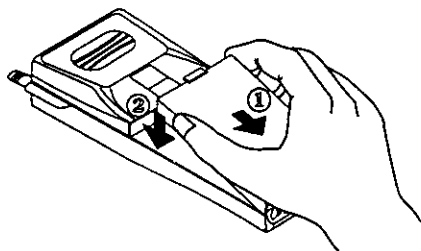
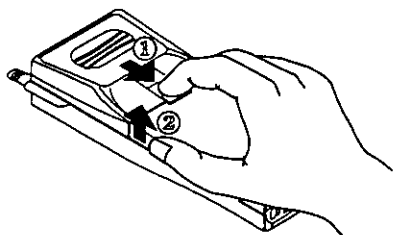

To remove the battery pack, perform the following steps

- 1 Place the handset face-down on a soft, protective surface to avoid accidentally scratching the display window
- 2 Move the battery release to the "down" position
- 3 Gently lift the battery away from the back of the handset

Charging Procedures

The battery pack may be charged using one of three charger units

- Travel Charger, EB-P10150
- Optional Rapid Charger, EB-P10151 (in Kit EB-911)
- Optional Handsfree Unit/Rapid Charger Cradle EB-J10139 (in Handsfree Car Mount Kit, EB-905)

Regardless of the selected unit, always observe the following charging precautions:

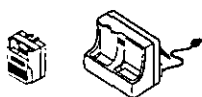

- Only use the battery charging accessories approved by Panasonic to maintain the full performance of your phone and to avoid potential damage. Using attachments not recommended or sold by Panasonic may result in fire risk, electrical shock, or injury. Panasonic is not responsible for damages caused by the use of inferior accessories.



- The battery may become warm while charging and remain warm for a short time after charging has finished. This is normal—do not consider this a malfunction!

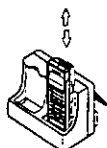

- Repeatedly inserting and removing a battery from the charger within short time periods, may result in overheating, ultimately shortening battery life.

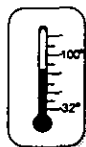

- Recharge batteries in well-ventilated places and in temperatures between +41°F to +104°F.

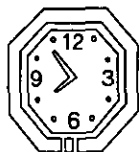

- Avoid recharging batteries for long time periods (over 24 hours).



- Never expose the charger to water, moisture, or extreme weather conditions.

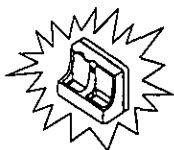

- If the charger has been subjected to extreme physical shock, do not attempt to use it. Instead, have it inspected by your Panasonic dealer.

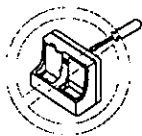

- Do not remove the screws or open the charger. No user-serviceable parts exist within the charger.

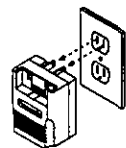

- Disconnect the AC plug from the power outlet when not using the charger.

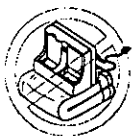

- Avoid using the Rapid Charger in places where heat dissipation is blocked, such as on soft surfaces (towels, blankets, etc.)

Travel Charger

The EB-P10150 Travel Charger "trickle" charges the battery to full capacity in approximately 10 hours depending on the surrounding room temperature

BATTERY TYPE	500mAH Nickel-Metal Hydride	900mAH Nickel-Cadmium
Charging Time	10 hours	10 hours

To charge your battery using the Travel Charger, perform the following steps

- 1 Open the prongs of the Travel Charger plug to the horizontal position and insert the charger into an AC power outlet
- 2 Remove the battery from the phone and insert the battery into the Travel Charger by aligning the battery terminals with the lower slot of charger case

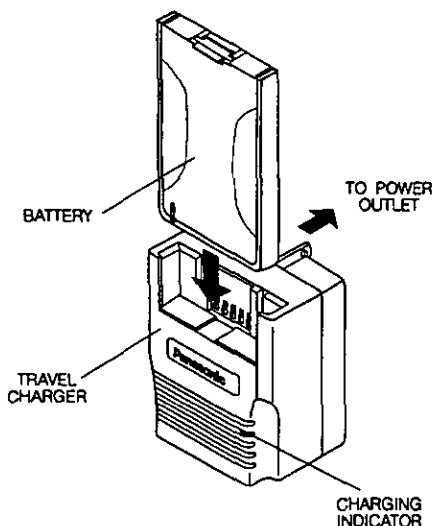

- 3 Firmly press the battery in place until you see the charger indicator lights. If not, re-insert the battery into the charger until the indicator comes "ON"

NOTE. *The charging indicator may not light if the battery is "deeply" discharged. Allow a deeply discharged battery to rest in the charger for a longer period. The charging indicator will light as the battery starts regaining its capacity.*

- 4 Full charging takes about 10 hours. When the battery is fully charged, the charging indicator will go "OFF"
- 5 Remove the battery from the charger

NOTES:

- *Even under normal conditions, the Travel Charger and battery become somewhat warm while charging.*
- *Charging automatically ceases and the indicator goes "OFF" after approximately 10 hours. To avoid interrupting this charging cycle time, do not disconnect the charger from the AC outlet until the battery is full charged.*
- *Charging time may vary depending on ambient room temperature.*

How to Extend/Retract the Antenna

To extend the antenna, slowly pull the antenna by its tip out and away from the base of the antenna barrel until it "clicks" into place

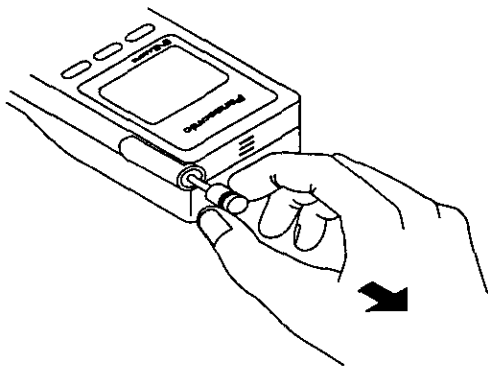

To retract the antenna, grasp the antenna from its upper-center portion and gently push the antenna back into the antenna barrel until it "snaps" into place

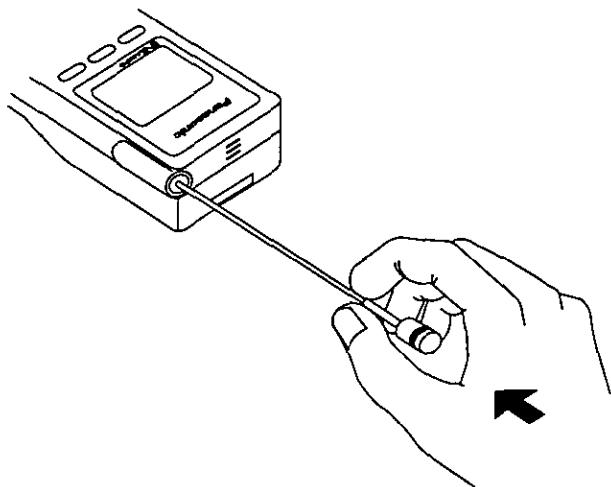

Attaching the Carrying Strap

Attach the carrying strap to the phone through the strap hole as shown in the following figure. Place the long loop through the smaller loop.

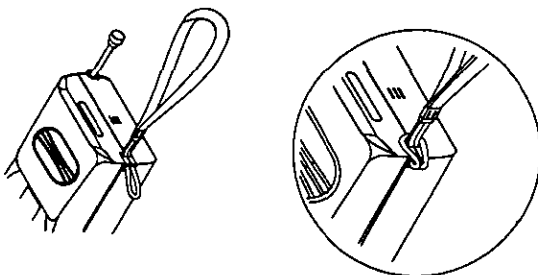

Cleaning

Clean the handset with a soft damp cloth moistened lightly with a mild dishwashing detergent and water. To avoid damage, **never use** petroleum-based cleaners or other harsh chemicals such as benzene or thinner.



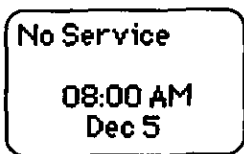

5. In about 1 second, the wake-up display message disappears and is replaced by the **No Service** message. If **No Service** remains on the display for an extended period, the handset is outside the service coverage area. Move to another place where you can make a call, or if your handset is programmed to operate on two selectable numbers, check your other number as a possible alternative.

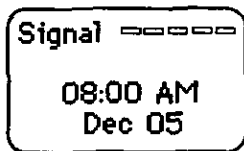

6. When the display indicates one of the following messages, the phone is ready for use:

- SIGNAL (within home area)
- ROAM N (non-wireline; outside home area)
- ROAM W (wireline; outside home area)

7. Note the  indication at the top right of the display designates the received signal strength levels from zero (minimum level) to five (maximum level).

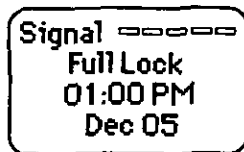

8. If any of the LOCK messages (**Dial Lock, Send Lock, Receive Lock, Theft Lock, Full Lock**) appear on the display, unlock your phone by entering the proper "unlock" code. (See page 3-57 for Lock details.)

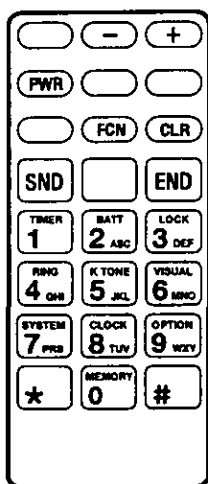

How to Make a Call

Keypad Sequence



- 1 Enter the desired number by pressing the appropriate digits on the keypad
- 2 Press **SND** key
- 3 Observe the display shows the **In Use** message to indicate the phone is attempting to make the call

NOTES:

- If you've made an error entering the number, briefly press **CLR** to clear the last entered digit, or hold down **CLR** until the entire display clears and enter the correct number
- The handset accepts 48 digits and 16 characters (Name Tag) but only the last 24 digits and first 12 characters appear on the initial display message. When input exceeds the limit, an Overflow condition occurs. To display the overflow digits, press **FCN**, release and press **FCN** again holding it down to display the entire message. In this example, the right arrow indicates the beginning of the number, while the left arrow indicates the end of the Name Tag
- Releasing the **FCN** key returns the display to the last ten digits entered

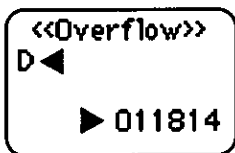
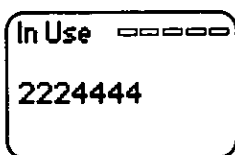

- 4 When connected, you'll hear the other voice from the earpiece. Adjust the earpiece volume using the **+** and **-** keys
- 5 When you've finished the call, press **END**

Auto Retry

Signal 
Auto Retry
08:00 AM
Dec 05

The phone redials the same number automatically (after the re-order tone; see next page) if connection fails (carrier system busy, low signal level, etc.). The phone redials every ten seconds up to a maximum of 15 times without any key operation.

To cancel Auto Retry redialing, press **END** (or in handsfree/car mount use, return the handset to the cradle).

NOTES:

- Redialing automatically ceases if an incoming call is received during a call-repeating interval.
- The phone does not redial if you reach a busy number.
- If you enter into a conversation by using Auto Retry, a tone will "beep" twice at the beginning of the call.

Automatic Redial

In Use 
2224444

To manually redial and call the last number called, simply press **SND**. The most recently called number momentarily appears on the display, and after pressing **SND**, is called as indicated by the **In Use** message.

NOTE: To review the last number called, you may use the "Last Ten Numbers Called" feature (**RCL** **MEMORY 0** **MEMORY 0** and **SND**).

Indicator Tones (with Unsuccessful Calls)

If a call you attempt to make on your handset is unsuccessful, you may hear one of the following tones

INTERCEPT:

The Intercept tone is a rapidly alternating high/low tone which normally occurs because the phone has detected an error, or is otherwise unable to make the call

RE-ORDER (fast busy):

A rapid dual tone (every 1/4th second) when the phone cannot make a call because of a busy channel within the coverage area, when a call is terminated by the other party, or a call is dropped in a weak signal conditions

If you hear a re-order or intercept tone, press **END** to stop the tone. However, if you wish to let the phone automatically go into Auto Retry mode, do not press **END**

How to Receive a Call

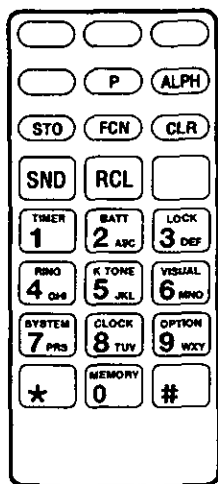

Keypad Sequence:



1. With power ON and receiving an incoming call, you'll hear a ringing tone, and see a flashing **Ring** message on the display. The entire display backlighting and keypad flashes as well.

NOTE: *With Escalating Ring Tone option ON, the ring tone grows louder every few seconds if you do not answer the call immediately.*

2. -Handheld Use:
Extend the antenna and answer the call by pressing any key except **PWR** or **END**.

-Handsfree/Car Mount Use:

Answer the call by pressing any key except **PWR** or **END** and talk into the handsfree microphone, or lift the phone from the cradle and use the handset. To switch from handsfree to handset mode, simply lift the handset from the cradle. To switch from handset to handsfree mode, first press and hold **MUTE**. When the handset displays the "HOLD" message, return the handset to the cradle.

3. When you've finished the call, press **END**, or in handsfree mode, simply return the handset to the cradle.



FCN 71 ○○○○○
Phone No 1
000-222-4444
< + , - or STO >

NOTES.

- To display your own phone number, use the **FCN** **SYSTEM 7** **MSG** **1** command as described in detail on page 3-76

Signal ○○○○○
RCVD 1 Call
08:00P 12/05

- If you do not answer a call, **RCVD Call** message shows the number of calls received but not answered up to 99 calls
See page 3-10 for details

Powering Off

Keypad Sequence:

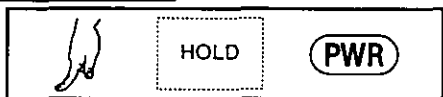
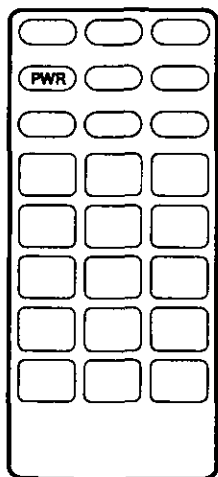

1. Power off the handset by pressing and holding **PWR** for more than half a second.
2. In handsfree car mount use, press and hold **PWR** for more than half a second, or turn the ignition switch to either OFF or LOCK position (ignition OFF).

NOTES:

- If you turn the vehicle ignition OFF without first pressing **PWR**, the phone powers ON automatically the next time you turn the vehicle ignition ON.
- While conversing on the phone and turning the ignition switch OFF, the phone will stay powered ON until you end the call.
- If Alert, Call Receive, or Received Call Indicator functions are active after the ignition switch is OFF (but phone power is ON), the display will indicate the particular function prior to powering the phone OFF.

Signal
Horn Alert
01:00 PM
Dec 05

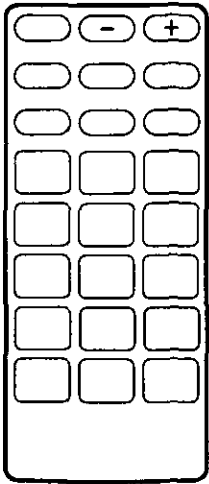

Additional Operations

Adjusting the Earpiece/Keytone Volume

Keypad Sequence:

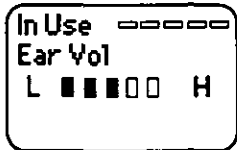
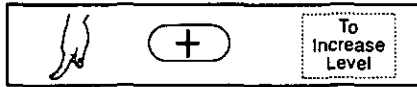

1. Make sure a call is in process (dialing is finished and the **In Use** or **MUTE** message appears on the display).

2. Adjust the *earpiece volume* up or down by pressing \oplus or \ominus respectively. The number of black bars indicate the present volume level (L for LOW, and H for HIGH). In handsfree/car mount use with the handset on the cradle, you'll hear the audio from the handsfree speaker. Adjust this level using the handsfree volume control.

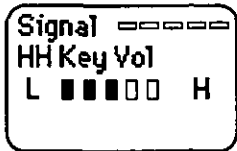

3. To adjust the *keytone volume* (produced when pressing keys), make sure the **In Use** and **MUTE** messages do not appear on the display.

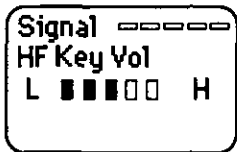

4. Press \oplus or \ominus to increase or decrease the volume. As with earpiece volume, the number of black bars indicate the present volume level (L for LOW, H for HIGH, EAR VOL for earpiece volume, and HF KEY VOL for handsfree key volume).

Received Call Indicator

Keypad Sequence:

To clear:

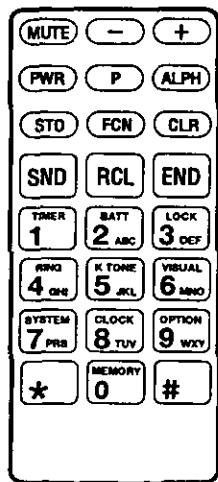

Received Call Indicator automatically informs you of up to 99 unanswered incoming calls in your absence by way of the **RCVD Call** message.

When receiving a call while away from your phone, or if the calling party terminates a call (or the call "drops" because of a fading signal before you are able to answer), the handset acknowledges and remembers the occurrence of these recent incoming calls.

1. No key entries are necessary to activate this mode. However, handset power must remain ON and Call Receive feature (see page 3-89) must not be active.
2. If an unanswered call has occurred, observe the **RCVD Call** message on the display. The time and date show when the most recent call was received. The number of calls received but not answered appear at the bottom of the display. The calling party's actual number is not displayed, nor does the phone store the number in this mode.
3. To clear the display, press any key.

NOTE: To recall the time of the last ten calls received but not answered, use Caller's Memory feature.

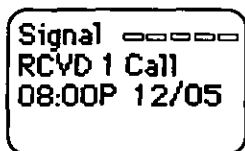

Mute

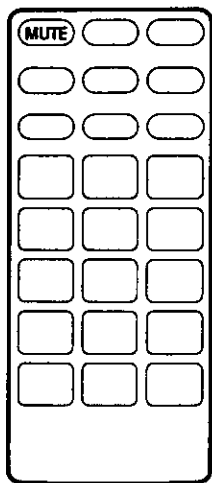

Keypad Sequence



Mute function allows turning the mouthpiece portion of the handset OFF during a call so that your voice is not transmitted to the other party

- 1 To mute the mouthpiece with a call in progress, briefly press **MUTE**
- 2 Observe the display shows the **MUTE** message while the mouthpiece is muted
- 3 To cancel, press **MUTE** again
- 4 In handsfree car mount use, cancel Mute by placing the handset onto the cradle and continue conversation with the handsfree mic

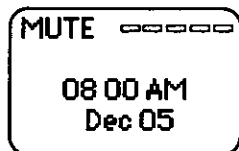

Hold

Keypad Sequence

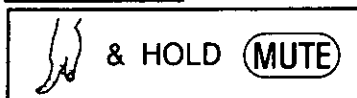

Hold function allows turning both the mouthpiece portion, and the earpiece portion of the handset OFF during a call. This stops both your voice from transmitting, and the caller's voice from being heard.

- 1 To activate Hold with a call in progress, press and hold **MUTE**

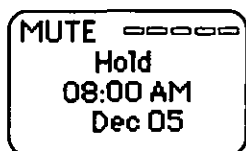

2. Observe the display shows the **MUTE** and **Hold** message while the mouthpiece and earpiece are muted. The handset also generates a hold tone to both parties while the hold function is active.
3. To cancel, press **MUTE** again. In handsfree car mount use, Hold function continues even after placing the handset onto the cradle. To continue the conversation using the handsfree mic, press **MUTE**.

Dual Tone Multi-Frequency (DTMF)

DTMF (commonly known as touch tones) are sets of unique tones generated when pressing a digit key (0-9), or **#** and ***** keys. These tones are most commonly used to access functions such as long distance access codes, voice mail retrieval, and other services.

Send DTMF tones during a conversation manually by pressing the appropriate digit keys.

NOTE: *Make sure keytones are active or "ON" (see page 3-72).*

DTMF Interval

When this option is activated by your dealer, the handset generates a continuous DTMF signal as long as you are pressing and holding the key.

NOTE: *DTMF transmission takes place regardless of whether Dial Lock (see page 3-57) is active or inactive.*

Flash Request

Flash Request allows accessing local phone system features such as call waiting, 3-way calling, etc , if available

To activate, press **[SND]** while a call is in progress and follow your service provider's instructions

NOTE: *Please contact your service provider for additional details*

How to Enter Alphanumeric Characters

To take full advantage of the many additional features of this handset, you must understand the process of entering alphanumeric characters and words. For example, you may wish to store a phone number with a corresponding name (Name Tags). Additionally, you may wish to store groups of numbers underneath a common heading (Group Labels). The following sections describe the general process of entering this information. ***For typical Name Tag and Group Label setup examples, see Appendix A.***

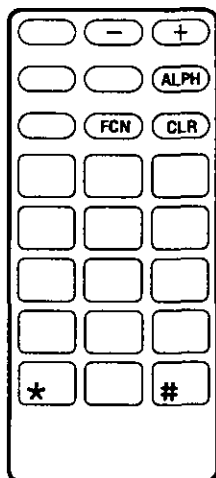

Entering Letters/Numbers

Keypad Sequence

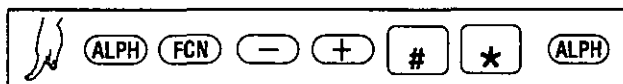

- 1 Enter Alphanumeric Input Mode by pressing **ALPH**.
Observe the current input display mode appears in the upper right-hand corner of the display.
- 2 Use **FCN** to scroll between 3 possible display modes:
 - A** Capital letters
 - a** Lowercase letters
 - 1** Numbers/symbols
- 3 Press **+** or **-** to scroll sequentially through the characters one at a time. Table 3.1 shows a complete list of available input characters.

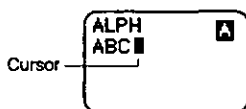
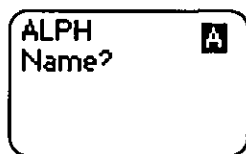

4. Press **#** to enter the selected letter and automatically move the cursor over to the next column

Table 3.1
Input Character List

INPUT MODE	CHARACTERS, DIGITS AND SYMBOLS
Upper-case Letters	A B C D E F G H I J K L M
	N O P Q R S T U V W X Y Z
Lower-case Letters	a b c d e f g h i j k l m
	n o p q r s t u v w x y z
Numerals/ Symbols	1 2 3 4 5 6 7 8 9 0 , ' "
	" , ? ! _ + - < > / \ [
] { } () ← → \$ £ ¥ ÷ = %
	& ^

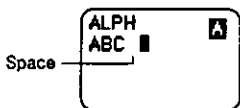

- 5 To enter a space between characters (or simply move the cursor to the right), press **#** with no characters currently selected. However, do not attempt to enter a "space" at the beginning of the line

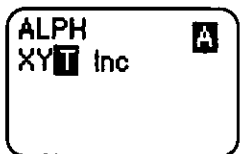

- 6 To correct an entry mistake (or to simply move the cursor to the left), press ***** to move the cursor one space at a time to the left until the cursor is on top of the character in error

For example, to change the letter "T" to "Z" as shown in the sample displays, press ***** several times until the cursor covers the letter "T"

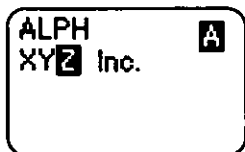

7. Enter the new character (Z, in this case) by scrolling with the \oplus or \ominus keys.
8. To delete characters one at a time, press CLR . To delete the entire entry, press and hold CLR for about 1 second.
9. When you're done making the entry, press ALPH .

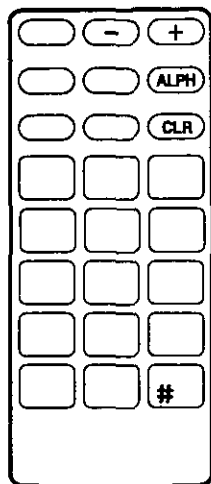

Word List

Keypad Sequence:

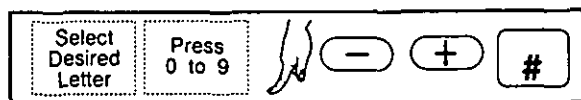

Your phone stores a large list of commonly used words in memory (see Table 3.2) to simplify the process of entering Name Tags and Group Labels. You may access the Word List any time the **ALPH** message appears on the display. A maximum of 10 words exist with any one single selected character.

NOTES:

- You cannot add words to the existing list.
- Searching the Word List is only possible when the cursor resides on the first letter of the word you're entering.
- If the sum of characters of the input word and the recalled word from the list exceeds 16 characters, the last characters of the recalled word are lost.

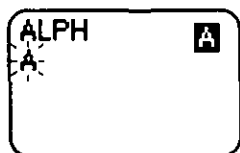

1. Verify that the phone is in ALPH mode.



2. Scroll to the first letter of the desired word. For example, "A" when you wish to locate the word "AIRLINE".

3. Press any of the digits between **MEMORY 0** to **OPTION 9**.

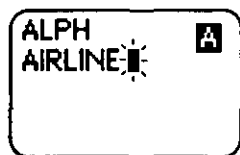

4. Scroll through the Word List using the **+** or **-** keys until the desired word appears. (Alternatively at this point, directly press **A-TONE 5** key according to the Word List described in Table 3.2.)

5. Press **#** to select the word, or to delete the word entirely, press **CLR**.

Table 3.2
Word List

KEYPAD NUMBER

	1	2	3	4	5	6	7	8	9	0
A	ACCT.	ADDRESS	AFTERNOON	AGENCY	AIRLINE	ANNIVERSARY	APRIL	AUG.	AVE.	AVG.
B	BANK	BANQUET	BAR	BEAUTICIAN	BIRTHDAY	BLDG.	BLVD.	BOOK	BOROUGH	BUSINESS
C	CAB	CALENDAR	CARRIER	CATEGORY	CHARGE	CITY	CLUB	CO.	CONFERENCE	CUSTOMER
D	DATE	DAY	DEALER	DEBT	DEC.	DEPARTMENT	DEPT	DIR.	DISTR.	DOCTOR
E	EAST	EDUCATION	EMERGENCY	ENTREPRENEUR	ETC.	EXAMPLE	EXECUTIVE	EVENING	EXPENSES	EXTRA
F	FAMILY	FAX	FEB.	FINANCE	FITNESS	FLIGHT	FLORIST	FRI.	FRIEND	FL.
G	GARAGE	GAS	GENERAL	GIFT	GOV.	GRAM	GRATUITY	GROSS	GUEST	GUIDE
H	HANDRESSER	HOLIDAY	HOME	HOSPITAL	HOTEL	HR				
I	ID.	INC.	INCH	INFO	INFORMATION	INN	INSURANCE	INTRO	INVESTIGATE	INVESTMENT
J	JAN.	JULY	JUNE							
K	KEY	KILO								
L	LAB	LAUNDRY	LAWYER	L.B.	LEGAL	LIMOUSINE	LOAN	LOG	LUNCH	
M	MAR.	MARKET	MAY	MEDICAL	MEETING	MID	MIN	MON	MOTEL	MOVIE
N	NET	NEWSPAPER	NIGHT	NO	NURSERY	NORTH	NOTE	NOV.	NOVELTY	
O	OCCUPATION	OCT.	OFF	OFFICE	OK	ON	OPEN	OTHERS	OUT	OZ.
P	PARKING	PAY	PERSONNEL	PHARMACY	PKWY.	POLICE	P.O.	PRICE	PT.	
Q	QT	QTY	QUALITY	QUOTA	QUOTATION	QUOTE				
R	RATE	RD.	REF.	RENT	RENTAL	RESORT	RESTAURANT	RETAIL	REV.	RTE.
S	SAT.	SCHEDULE	SCHOOL	SECRETARY	SEPT.	SPA	SOUTH	ST.	SUBL.	SUN.
T	TAXI	TECH	TELEX	THEATER	THU.	TRAIN	TRAVEL	TOWN	TRIP	TUE.
U	UNION	UNIVERSITY	URGENT	USER						
V	VEHICLE	VENDOR	VET	VIDEO	VIP					
W	WED.	WORK	WEST							
X	XMAS									
Y	YES									
Z	ZIP									

WORD INITIAL

Speed-Dial Memory

The Model HH950 uses a quick storage/recall method called Speed-Dial Memory. This feature provides a method of storing frequently used numbers and Name Tags, and recalling these numbers easily when needed. Each memory block contains up to 48 digits of number data, 16 characters for name tags, and 12 characters for group labels.

How to Store Using Speed Dial

The following chart shows the typical method and combination of entering and storing data in Speed-dial Memory:

1. Enter number
2. Enter Name Tag (optional)
3. Press **STO**

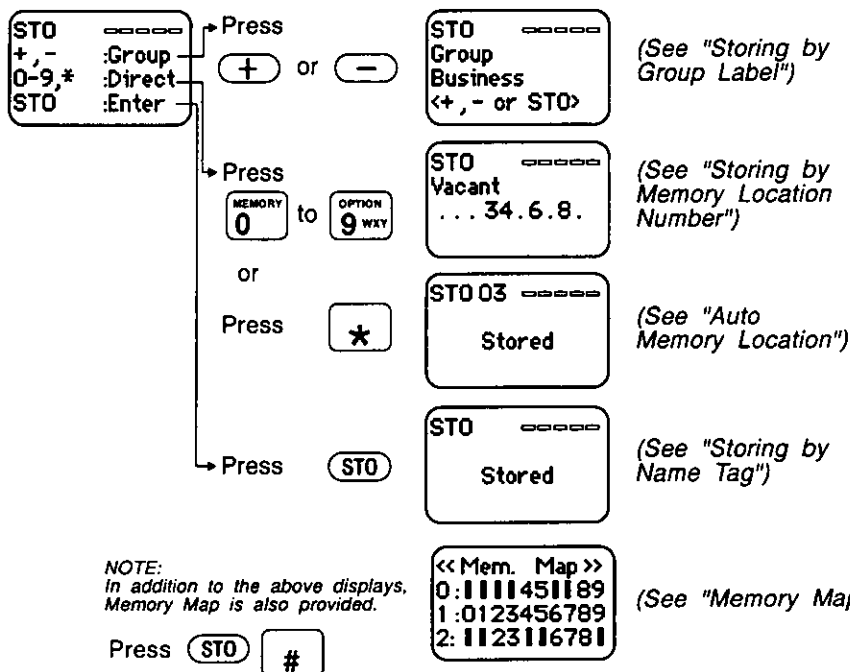

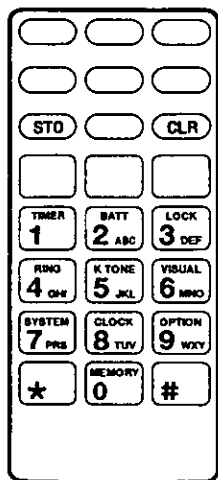

Storing by Memory Location Number

Keypad Sequence:

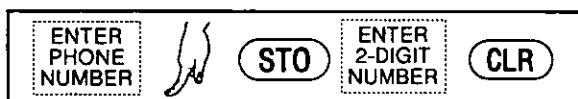

The HH950 has the ability to store 200 Speed-Dial memory numbers of which 99 are accessible directly using the **RCL** 01 to 99 memory locations. The other 101 locations are accessed directly using the **RCL** **ALPH** (recall by Group Label) or **RCL** **RCL** (recall by Name Tag) functions.

NOTE: Do not attempt to store information in memory slot location 00.

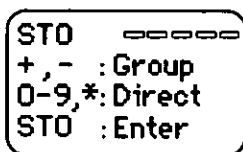

1. Enter the desired phone number you wish to store.
2. Press **STO** .

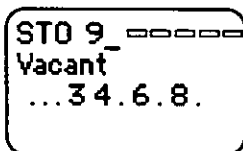

3. Select and enter the 2-digit memory location number between 01 to 99.
For example, to store a number within memory location number 93, first press **OPTION 9** and note the display now shows a listing of the "nine" numbers which are currently vacant. In this example, locations 93, 94, 96, and 98 are vacant. Therefore, press **LOCK 3** to complete storage in memory location 93.

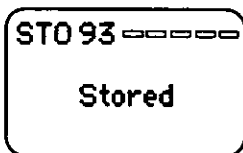

4. Record the number in Speed-Dial Index, Appendix B.
5. To escape from this mode, press **CLR** .

NOTE: To recall, enter **RCL** and the 2-digit number as described later on page 3-28.

Auto Memory Location

Auto Memory Location, as its name implies, automatically selects the lowest available vacant memory location slot and stores your number there.

1. To automatically store a number on the lowest available memory slot, enter the desired phone number and press **STO** and *****.
2. To store on the lowest vacant memory location within a block of ten locations, enter the desired phone number, press **STO**, **MEMORY 0** to **OPTION 9 WAY**, and *****. For example, to store on the lowest vacant memory location in the series from 50 to 59 (50 on the left), press **STO**, **5 TONE**, and *****.
3. To escape from this mode, press **CLR**.

STO 05

Stored

STO 5

Vacant

012..5..89

STO 5

User's Mem Full

STO 5

All Occupied

NOTES:

- When the message **User's Mem Full** appears on the display, memory capacity is exhausted and will not accept any additional information.
- When the message **All Occupied** appears on the display, all memory location slots in a block of ten locations are full. You may replace an occupied location with your new name and number (see *Override Protection*, page 3-23).

Memory Map

Memory Map allows determining which memory location slots are available in the Speed-Dial Memory when storing new numbers.

1. To enter Memory Map mode, press **STO** and **#**.

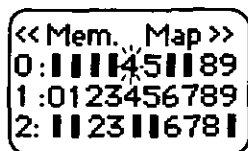

```
<< Mem. Map >>
0: ||| | 4 | | 8 9
   | | | | * | |
1: | 0 | 1 | 2 | 3 | 4 | 5 | 6 | 7 | 8 | 9
2: | | 1 | 2 | | | 6 | 7 | | 8 | 9
```

2. Observe the display shows the first 3 lines of the memory map. The solid bar indicates a number has already been stored in this particular memory location slot. A digit, however, indicates that the slot is open. A flashing number indicates the first available open slot (04 in this display example). To store information at this first open slot, press *****.

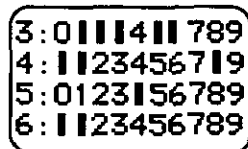

```
3: | 0 | | | | 4 | | 7 | 8 | 9
4: | | 1 | | 2 | 3 | 4 | 5 | 6 | 7 | 8 | 9
5: | 0 | 1 | 2 | 3 | | 5 | 6 | 7 | 8 | 9
6: | | 1 | | 2 | 3 | 4 | 5 | 6 | 7 | 8 | 9
```

3. To scroll through the possible ten lines (0 through 9) of the Memory Map display, press **+** or **-**.

4. Choose the memory location slot in which you wish to store your information by entering the appropriate 2-digit location number from 01 to 99.

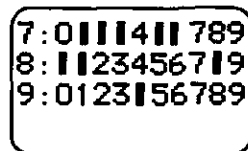

```
7: | 0 | | | | 4 | | 7 | 8 | 9
8: | | 1 | | 2 | 3 | 4 | 5 | 6 | 7 | 8 | 9
9: | 0 | 1 | 2 | 3 | | 5 | 6 | 7 | 8 | 9
```

Override Protection

Override Protection protects you from storing new phone numbers over an already occupied memory location slot. When attempting to store a new number over an occupied memory location, the contents of the memory location will flash on the second and third lines of the display.

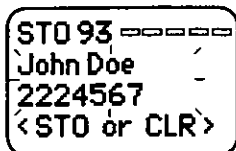

- 1 To escape at this point without storing the new number and return to the previous step, press **CLR**
- 2 To store the new number in this location, press **STO**. While the new number is stored in this location, the old number remains in memory without a memory location slot number.
- 3 To escape from this mode, press **CLR**

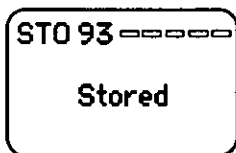

Storing by Name Tag

Keypad Sequence

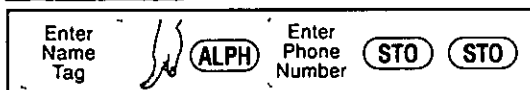

Storing numbers together with a Name Tag, allows you to later recall those numbers by scrolling through each Name Tag in alphanumeric order and recalling (see page 3-30 for recall details).

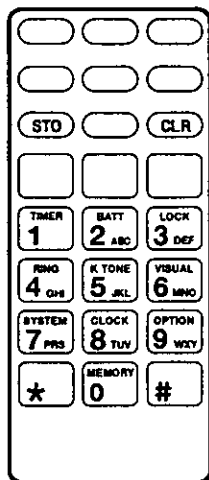

Signal
Joe Doe

1. To store phone numbers with a Name Tag, recall or create a Name Tag by following the procedures described previously. You may create your own Name Tag, or use one from the Word List (see Table 3.2). Be sure to press the **(ALPH)** key when you're done entering the Name Tag.

Signal
Joe Doe
2224444

2. Enter the phone number.

STO
+,- :Group
0-9,*:Direct
STO :Enter

3. Press **(STO)**.
4. At this point, to store the information also by memory location slot number, enter the desired two-digit Memory Location Number.

STO 93

Stored

5. Otherwise, press **(STO)**.
6. To escape from this mode, press **(CLR)**.

NOTE: To recall, enter **(RCL)** **(ALPH)** **(+)** / **(-)** as described later on page 3-30.

Storing by Group Label

Keypad Sequence:

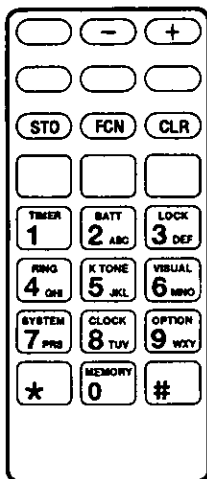
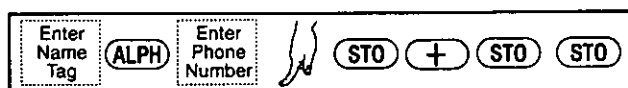

Group Label feature allows storing information in up to thirty different "groups" having customized group label names. When you wish to recall data stored within a Group Label, you simply recall the specific Group Label first, and then search through the Speed-Dial Memory within that group.

1. Verify the existence of, or create a Group Label by entering **FCN** **MEMORY 0** and **BATT 2 ABC** (see page 3-94 for additional details). Press **CLR** when completed.
2. Enter the desired alphanumeric information such as Name Tags, phone numbers, etc., as described previously on pages 3-14.

NOTE: To place "already existing" Name Tags underneath a Group Label, use the Speed-Dial Memory Edit feature (see page 3-33).

3. Press **STO** and **+ .** (Observe the first Group Label in alphabetical order appears on the display.)

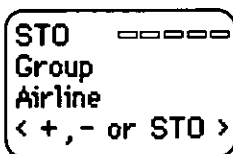

NOTE: If no Group Labels are presently stored, the message "Temporary" appears.

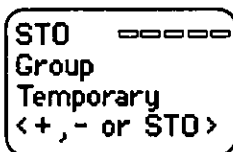

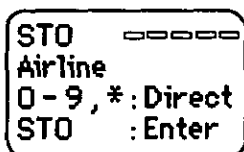

4. Scroll through the Group Labels using the \oplus and \ominus keys. When you find the Group Label where you wish to store data, press STO .

NOTE: At this point to store this same data also by memory location number, enter the desired two-digit Memory Location Number.

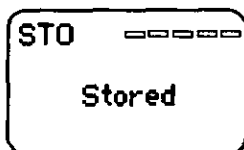

5. To save the data with this particular Group Label, press STO once again.
6. To escape from this mode, press CLR .

NOTE: To recall from the main display, enter RCL RCL \oplus / \ominus RCL \oplus / \ominus (see page 3-31 for details).

Using Recall

The following chart shows the typical method of recalling data in Speed-dial Memory:

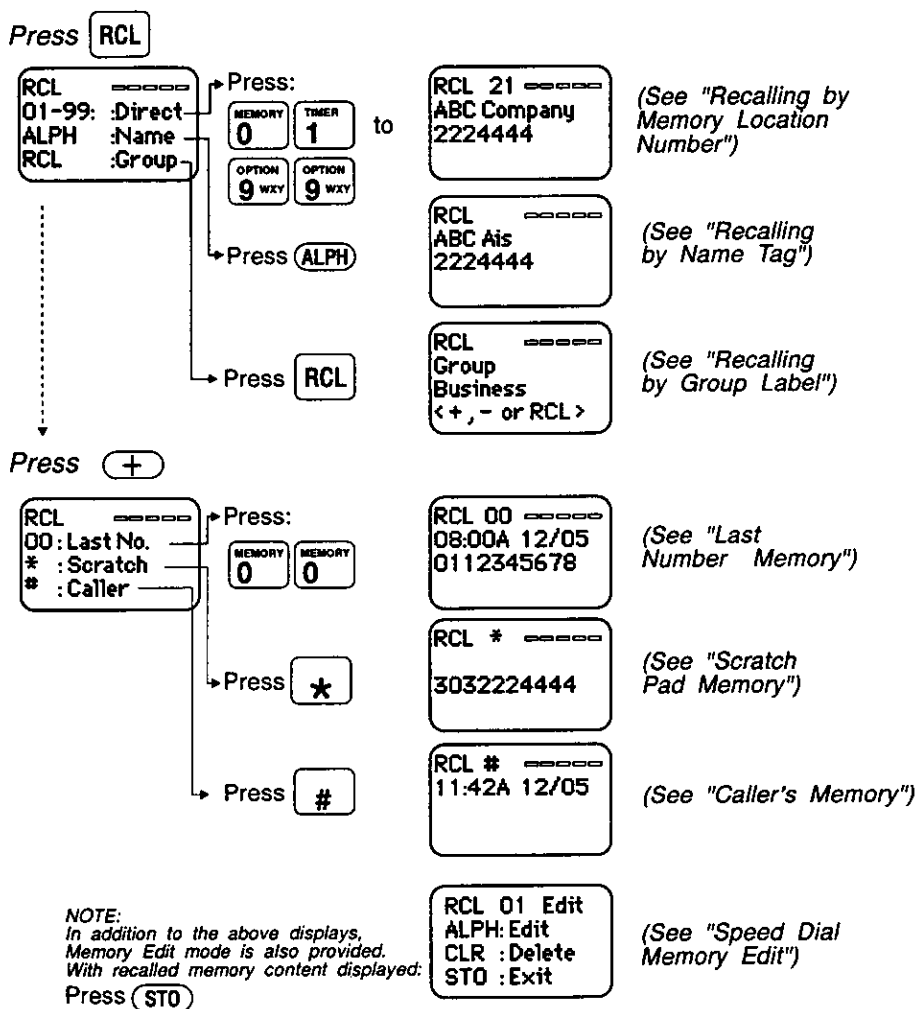

Recalling by Memory Location Number

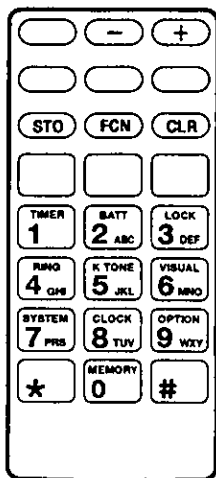

Keypad Sequence:



1. To recall a Speed-Dial Memory using a Memory Location Number, press **RCL** and enter the two-digit Memory Location number from 01 to 99.

For example, to recall a number stored with memory location 21 named "ABC Car Rental", press **RCL** and **BATT 2 ABC**. A display message similar to that shown here appears indicating which "2" series memory locations contain data. For this example, note that locations 20, 21, 25, and 26 contain data.

Press **TIMER 1** to complete the 21 entry for memory location.

2. To scroll through other occupied memory locations, use the **(+)** and **(-)** keys. Pressing **(+)** once moves the display to the next occupied memory location (in this case, 25).

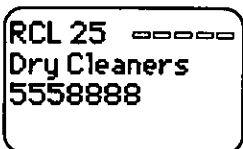
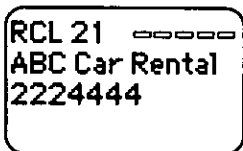
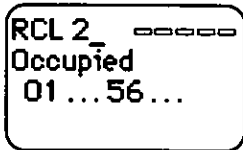

RCL 2_ ▯▯▯▯
Non Occupied
.....

NOTE: *If no information is stored within any of the slots of the required set of locations, the message "Non Occupied" appears on the second line.*

Signal ▯▯▯▯
08:00 AM
Dec 05

Super-Speed Dialing

Super-Speed Dialing allows dialing a number directly from Speed-Dial Memory by merely entering a memory location number and pressing **[SND]**.

Signal ▯▯▯▯
2

1. To use Super-Speed Dialing, from a normal display enter the Memory Location for the desired number. For example, to access the contents of location 02, press **[2^{MEM}]**.

NOTE: *If the memory location number starts with zero, drop the initial zero and enter the last digit. Enter both digits if the first digit is 1 through 9.*

In Use ▯▯▯▯
2224444

2. Press **[SND]**. Note the stored phone number temporarily appears on the display.

In Use ▯▯▯▯
08:00 AM
Dec 05

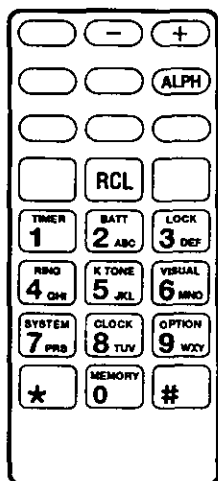

Recalling by Name Tag

Keypad Sequence:



RCL 21 - - - -
ABC Car Rental
2224444

1. To recall a Speed-Dial Memory by a Name Tag, press **RCL** and **ALPH**. Observe the display shows the first name tag found using alphabetical order.

RCL - - - -
S

2. Briefly press **+** to scroll through the information whose name tag begins with the same letter. To scroll forward through each letter, press and hold **+** to display one letter at a time. Press **-** to scroll backwards.
3. When you reach the letter starting with the name tag you're searching, release the **+** or **-** keys. Note the first name that begins with that particular letter appears on the display.

RCL 32 - - - -
Smith
8884444

4. Scroll through the information with the same letter by pressing **+** and **-**.

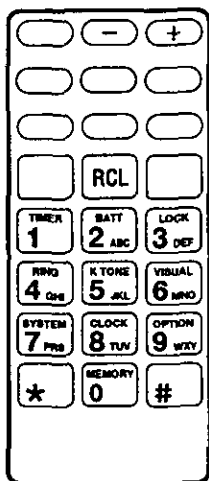

Recalling by Group Label

Keypad Sequence:

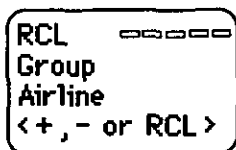
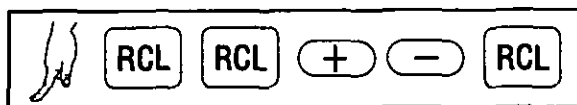

1. To recall a Speed-Dial memory by Group Label name, press **RCL** **RCL** . Observe the display shows the first Group Label name found in alphabetical order.

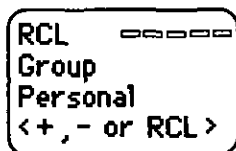

2. Briefly press **+** or **-** scroll through the Group Labels.

3. When you reach the Group Label you're searching, press **RCL** .

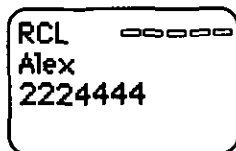

4. Scroll through the information with the same Group Label by pressing **+** and **-** .

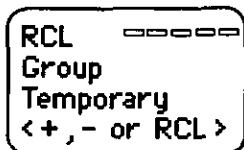

NOTE: *If a Group Label consists of only one label, while scrolling the display shows a **"Temporary"** message, or goes back to the original display.*

Speed-Dial Memory Edit

Changing Memory Contents

The following steps describe how to edit the memory contents of "already existing" Name Tags, phone numbers, Group Labels, and Direct Memory Location numbers.

Keypad Sequence:

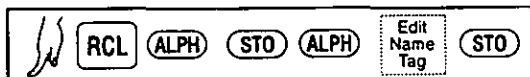

1. Recall the Memory contents to be edited (press **RCL** and 01 to 99, **ALPH**, or **RCL**). In this example, we've used **ALPH** to recall Name Tag ABC Car Rental.

2. Press **STO**.

3. Press **ALPH** for Edit function.

4. Edit the name (if necessary) according to alphanumeric entry procedures described previously on page 3-14. Press **STO** when complete.

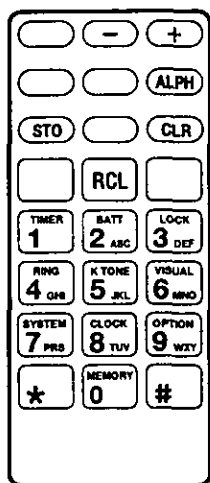

RCL 21 **ALPH**
ABC Car Rental
2224444

RCL 21 **Edit**
ALPH: Edit
CLR : Delete
STO : Exit

RCL 21 **Edit** **A**
Name?
ABC Car Rental

RCL 21 Edit
Tel No?
2224444

5. Change the number (if required) using the **(CLR)** key and re-entering the desired digits. Press **(STO)** when complete.

RCL 21 Edit
Group?
BUSINESS
< +, - or STO >

6. Change the Group Name (if any) using the **(+)** and **(-)** keys. Press **(STO)** when complete.

RCL 21 Edit
Direct No.?
93
< digits, STO >

7. Edit the Direct No. (if any) by entering the new digits. Press **(STO)** when complete.

STO 93 **=====**

Stored

8. Press **(CLR)** to escape this mode.

Deleting Memory Contents

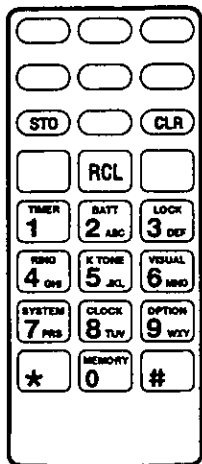

Keypad Sequence

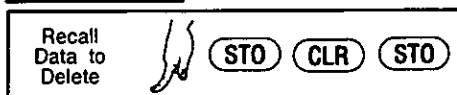

RCL 21
ABC Car Rental
2224444

- 1 Recall the memory contents you wish to delete

RCL 21 Edit
ALPH Edit
CLR · Delete
STO · Exit

- 2 Press **STO**

RCL 21 Edit
ABC Car Rental
2224444
< STO:Delete >

- 3 Press **CLR**

RCL 21 Edit

- 4 Delete the data by pressing **STO**

Deleted

- 5 The phone automatically exits this mode after three seconds

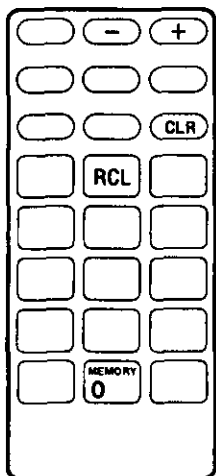

Last Number Memory (Display 10 most recently called numbers)

Keypad Sequence:



Last Number Memory feature stores the 10 most recently called numbers in memory and maintains, along with those numbers, a date and time log for the call. When the 11th number is stored, the oldest number is automatically deleted.

1. Press **RCL** **MEMORY 0** **MEMORY 0**.
2. Observe the last number, time, and date message appears.
3. Use the **(+)** key to move back through the list of last ten calls made.
4. Use the **(-)** key to move forward through the list.

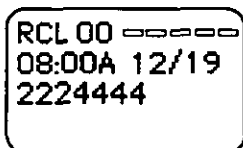

NOTE: *The last call information remains in memory even when the phone is powered OFF and then ON, but will clear automatically when the phone enters the Dial Lock condition (see page 3-57).*

5. Press **CLR** to escape this mode, or press **SND** to call the displayed phone number.

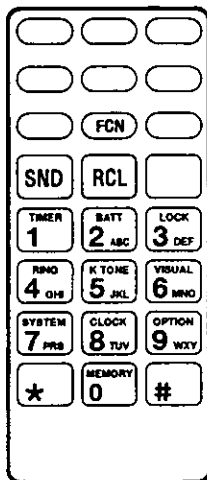

Scratch Pad Memory

Keypad Sequence:

To Store



To Recall



Scratch Pad Memory allows using the keypad and display as a "scratch pad" to enter and store numbers in memory during a conversation.

1. To store numbers entered in the Scratch Pad, enter the desired digits using the keypad.
2. The phone automatically memorizes the digits when you END the call.

NOTE:- Remember as you enter digits during a conversation, the key tones are sent to the party on the other end of the conversation as well. To silence the keytone, use the

FCN **E TONE** **5** **JUL** command (see page 3-72 for details).

When powering the phone OFF, the contents of Scratch Pad Memory is erased.

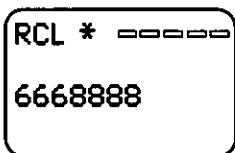

3. To recall the number stored in Scratch Pad, press **RCL** and *****.

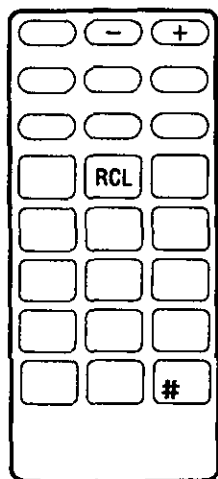

Caller's Memory

Keypad Sequence:

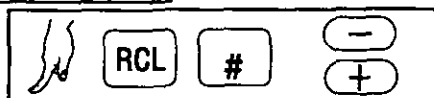

This feature allows reviewing the time of up to the last 10 calls you have received but not answered. When you receive more than 10 calls, the oldest number is deleted.

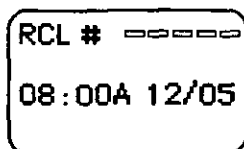

1. To use Caller's Memory, press **RCL** **#**. Observe the last caller's time and date stamp appears.
2. Press **+** and **-** keys to scroll through the list of 10 calls received but not answered.

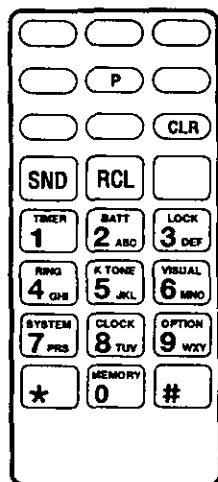

DTMF From Memory

Keypad Sequence:

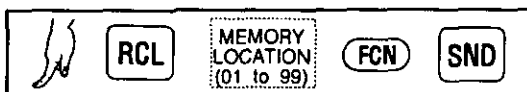

This feature allows sending DTMF tones from Speed-dial memory location number.

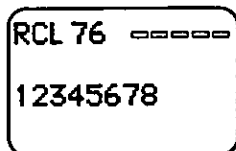

1. To send DTMF tones, press **RCL** and enter the memory location number. Observe the digits appear on the display.
2. Press **FCN** and **SND** keys. The phone automatically sends the displayed number with DTMF tones.

Prefixed Dialing

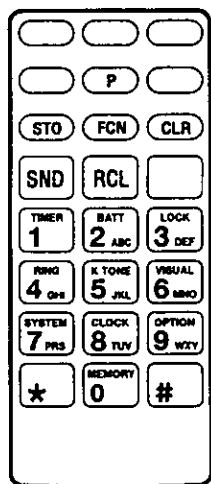

Keypad Sequence:

To store/recall:



Prefix Dialing allows storing the prefix of commonly-dialed numbers (area codes, common system prefixes, local system access codes, etc.) into the handset for later recall by merely pressing **P**. Prefixes may be up to 32 digits long.

1. To store a prefixed dial, first verify that no digits are presently entered in the display, and that the handset is not in a Dial Lock condition (see page 3-57).
2. Press **P**. Assuming no previous prefix has been entered, observe the "0-" display message.
3. Enter the desired sequence (up to 32 digits) and press **RCL** to store this prefix into memory. In this example, we've entered 1 2 3 as the prefix.

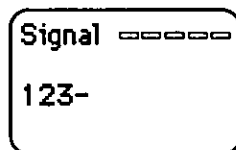
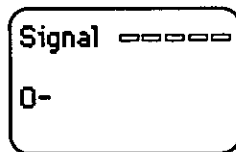

RCL 0000
01-99 : Direct
ALPH : None
RCL : Group

4. Press CLR to escape this mode.
5. To later recall a stored prefix, make sure the display is clear and press P.
6. Enter the remainder of the number using Speed Dial Memory feature.
7. Press SND to complete the call.

Signal 0000
123-4567

NOTE: • *If the sum of the digits in the prefixed dial and the entered (or recalled) number exceeds 48 digits, the last digits of the number will be lost.*

If a number already appears on the LCD, pressing P displays a "P" message at the end of the number for Pause Dial (see page 3-41).

Pause Dial

With special phone services such as long distance access codes, voice mail, and other services, you may find it necessary to dial several groups of digits with short wait times between the groups to allow the system time to respond. Pause Dial simplifies this procedure by allowing you to store and dial up to ten different total sequences of numbers. Pauses, programmed between the digits, allow adequate response time between the various dialing steps. Proceeding from a "pause" simply requires pressing the

SND key.

For example, suppose you wish to access your office voice mailbox from your handset. With typical voice mail systems, this requires the following steps:

- Dial your office phone number
- Access your voice mail system extension number
- Enter your personal password...and so on.

Using Pause Dial, you can simplify this operation by programming the phone to automatically dial all of the necessary digits, and enter pauses where appropriate to allow the voice mail system time to complete the various stages of processing.

Assuming you've properly programmed your phone for Pause Dial, this procedure might operate as shown in the following table:

STEP	KEYPAD ENTRY/RESPONSE
Dial Office Number	<ul style="list-style-type: none">• Press RCL• Enter proper memory number (01 to 99)• Press SND• System Pauses
Access Voice Mail extension number	<ul style="list-style-type: none">• Press SND• System Pauses

STEP	KEYPAD ENTRY/RESPONSE
Enter Personal Password	<ul style="list-style-type: none"> • Press [SND] • System Pauses

The following sections describe how to program and use Pause Dial.

How to Program and Use Pause Dial

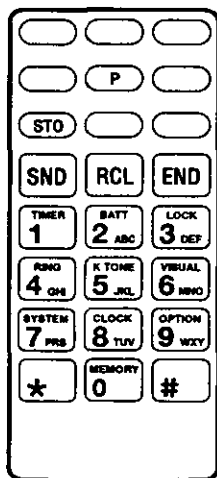

Keypad Sequence:

To program:



1. To program Pause Dial, make sure the display entry field contains the initial phone number to be called.
2. Press **[P]**. Note a "P" appears on the display to indicate a pause command.
3. Enter the second series of desired digits and press **[P]**.
4. Repeat step 3 as many times as necessary to complete the entry. The Pause Dial sequence may contain up to 48 digits (including "P"s).
5. To store this pause dial sequence into memory for later recall, press **[STO]** and enter the 2-digit memory slot location number between 01 to 99.
6. Press **[SND]** to begin making a call using this Pause Dial sequence. Wait for initial connection of the call.
7. Each time the handset encounters a "P" for pause, press **[SND]** to continue the entry process.

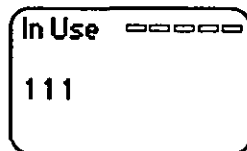
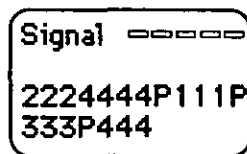

NOTES:

- During initial Pause Dial programming, if you press **P** when no dialed number is presently entered and displayed, the current Prefixed Dialed number appears on the display.

- If so desired, you may program the Pause Dial sequence by combining several Speed-Dial memory sequences instead of entering actual numbers. To do so, press **RCL**, enter previously programmed memory location number (01 to 99), press **P**, press **RCL**, enter memory location number, and so on repeating this procedure as necessary.

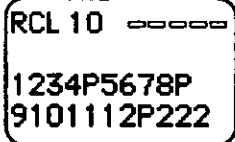

RCL 10 □□□□□
1234P5678P
9101112P222

Function Key Operation

Using the Function Guide

Press **FCN**

FCN_ _ _ _ _
* Messaging
1: Call Timer
2: Battery

Press



FCN * _ _ _ _
1: CallBack 3
2: Short Msg 5
3: V-Mail 7

(See "Enhanced Features, Optional")

Press



FCN 1 _ _ _ _
Last Timer
12min 34sec
< + , - : Scroll >

(See "Call Length Timer FCN1")

Press



FCN 2_ _ _ _
1: Batt Meter
2: Pace Beep

(See "Battery FCN 2")

Press **+**

FCN_ _ _ _ _
3: Security
4: Ringing
5: Key Tone

Press



FCN 3_ _ _ _
1: Lock Level
2: Dial Limit
3: Mem Secret

(See "Security FCN 3")

Press



FCN 3_ _ _ _
4: Theft Lock
5: Master FCN
6: Theft Code

(See "Security FCN 3")

Press



FCN 3_ _ _ _
7: New Code

(See "Security FCN 3")

Press



FCN 4_ _ _ _
1: Ring Vol
2: Ring Tone
3: Escalating

(See "Ringing FCN 4")

Press



FCN 4_ _ _ _
4: Auto Ans.

(See "Auto Answer")

Press



FCN 5_ _ _ _
Key Tone
On
< + , - or STO >

(See "Keytones On/Off FCN 5")

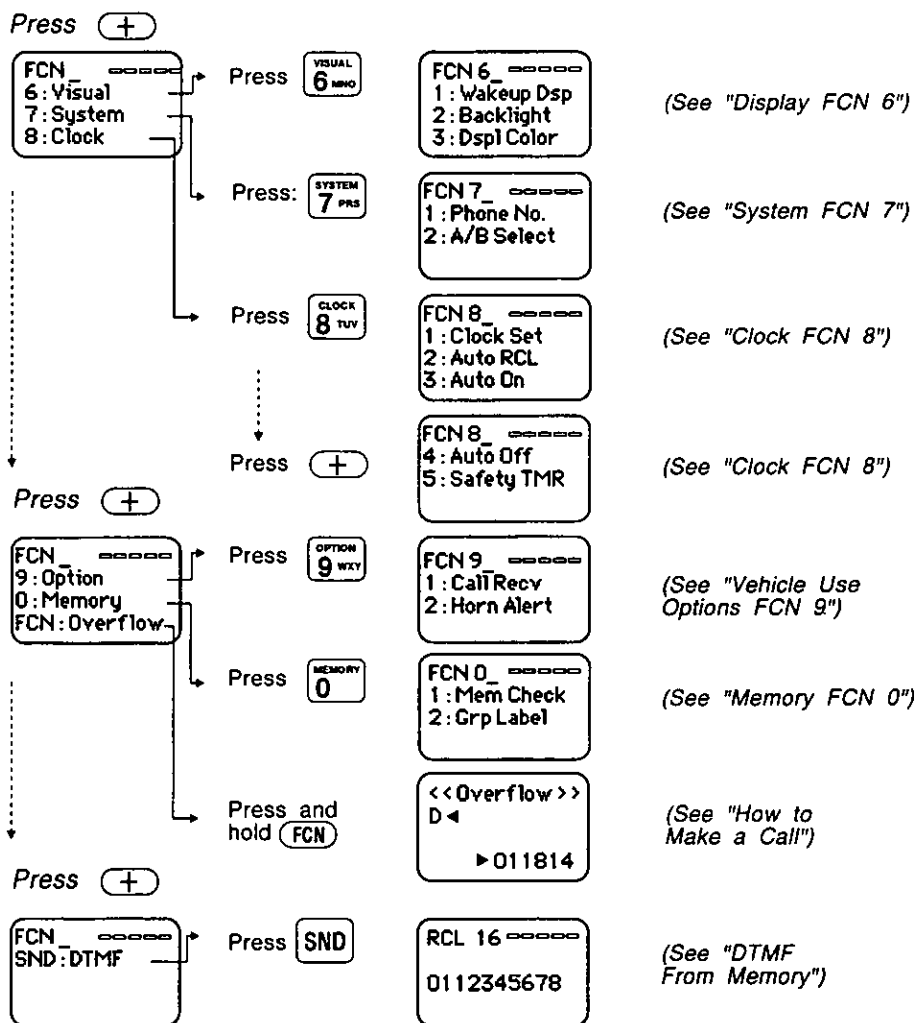

Enhanced Features (Cellular System Optional)

Because the HH950 uses "extended protocol messaging", several additional cellular features are available including:

- **Call-Back Number** - a digital page (permits convenient call back)
- **Short Messages** - allows access to messages received from cellular service provider
- **Voice Mail Status** - shows number of voice mail messages received from cellular service provider

These features operate over a technology known as Narrow-Band AMPS (or NAMPS), and may be offered by your cellular phone service provider. Please contact your service provider for additional details not covered in the following discussions.

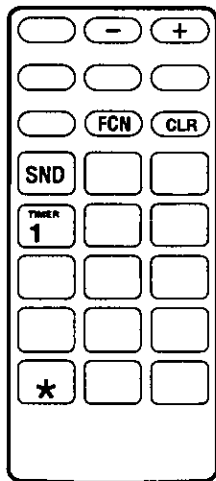

Call-Back Number (CLI)

Keypad Sequence:

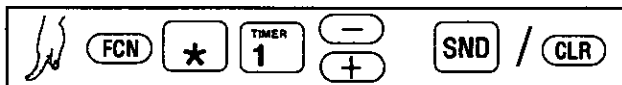

Call-Back Number feature displays the last 10 digital pages. This provides a convenient method of recalling the numbers and easily making return calls if so desired.

Since Call-Back feature is always active when the phone is powered ON, the phone automatically sounds *one* beep tone and displays one of the following messages every time a Call-Back Message is received:

This display appears when the phone has received only one Call-Back Message, and no other enhanced feature messages (Voice Mail, Short Message, etc.) or /conventional cellular phone calls. In this condition, the

Signal
02:18P 12/05
Call Back
2224444

message contains a time/date stamp and up to a 12-digit (32 digits are possible) message. If the message is a phone number, you may press SND to make a call to that number. Otherwise, this message remains on the display until you press any key (except PWR).

Signal
02:18P 12/05
Call Back
◀12345678987

If the message is greater than 12 digits, a display overload indicator appears as shown here. This display, for example, shows the final 11 digits of the number. Press FCN * 1 (as described later) to read the initial digits.

Signal
RCYD 1 Call
02:18P 12/05
FCN*:Msgs

This display appears when the phone has received one or more Call-Back Messages along with other enhanced features messages and/or conventional cellular telephone calls. This display example shows that 1 cellular call has been received, as well as one or more enhanced feature messages as indicated by the "FCN*:Msgs" line.

To recall multiple Call-Back messages, perform the following steps:

1. Press FCN * and observe the following display:

FCN *
1: CallBack 3
2: ShortMsg 0

NOTE: *The number to the right of "1: CallBack" indicates the number of messages received since you last entered this particular menu. Each time you press "1" for CallBack, the Callback number column resets to "zero" the next time you access this menu.*

2. Press 1 key to select CallBack. Observe the most recent Call-Back Message appears on the display. This display holds up to ten Call-Back Messages with the newest message displayed first. To scroll through the ten possible messages, use the + and - keys.
3. When you're done reading the message, either press SND to make a call to the displayed number, or press CLR to exit.

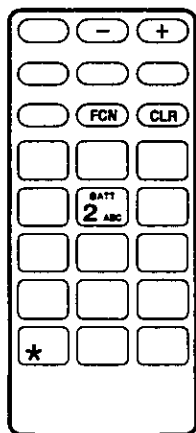

Short Message

Keypad Sequence:

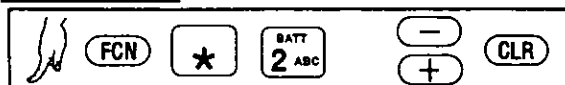

Short Message feature allows recalling and displaying actual short messages (up to 14 characters long) from the cellular service provider system base site.

Since Short Message feature is always active when the phone is powered ON, the phone automatically sounds *two* beep tones and shows one of the following displays every time a Short Message is received:

Signal -----
 02:18P 12/05
 Message:
 Call home

This display appears when the phone has received only one Short Message, and no other enhanced feature messages (Voice Mail, CLI, etc.) and/or conventional cellular calls. In this condition, the message contains a time/date stamp and a 14-character message. This display remains until you press any key (except **(PWR)**).

Signal -----
 RCVD 1 Call
 02:18P 12/05
 FCN *:Msgs

This display appears when the phone has received one or more Short Messages along with other enhanced features messages (such as Short Messages and CLI messages) and/or cellular calls. This display example shows that 1 cellular call has been received, as well as one or more enhanced feature messages as indicated by the "FCN*:Msgs" line.

FCN * -----
 1: CallBack 0
 2: ShortMsg 3

To recall multiple Short Messages, perform the following steps:

1. Press **(FCN)** **(*)** and observe the following display:

NOTE: *The number to the right of "2: ShortMsg" indicates the number of messages received since you last entered this particular menu. Each time you press "2" for ShortMsg, the ShortMsg number column resets to "zero" the next time you access this menu.*

FCN *2-----
09:15A 12/05
CALL
OFFICE

2. Press **[MNF 2]** key to select Short Message. Observe the most recent Short Message appears on the display. This menu holds ten Short Messages with the latest message displayed first. To scroll through the ten messages, use the **[+]** and **[-]** keys.

FCN *2-----
09:15A 12/05
◀RIGHT AWAY

NOTE: If your message is longer than allowed display area, a display overload indicator arrow appears. In this example, the left arrow indicates more information precedes this screen. To display the previous screens, press **[-]**. To move forward through the screens, press **[+]**.

FCN *2-----
09:15A 12/05
CALL
OFFICE ▶

3. When you're done reading the message, press **[CLR]** to exit.

Voice Mail

Keypad Sequence:

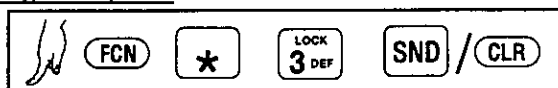

Voice Mail allows recalling and displaying voice mail "status" messages from the cellular system. In this mode, the phone may show all or part of the following information:

- Status messages such as a phone number to call to hear your messages.
- an **URG!** (urgency) indicator
- the number (from 1 to 99) of awaiting voice mail messages

Since Voice Mail feature is always active when the phone is powered ON, the phone automatically sounds three beep

tones and shows one of the following displays every time a voice mail message is received:

Signal
02:18P 12/05
Voice Mail:
2224444

This display appears when the phone has received only one Voice Mail message, and no other enhanced messages (Short Messages, Call-Back Messages, etc.) and/or conventional cellular calls. In this condition, note the message contains a time/date stamp and a message. If the message is a phone number, you may press to make a call to that number.

Signal
02:18P 12/05
V.Mail: URG!
2224444

This display appears when the phone has received one Voice Mail message along with the **URG!** message, and no other enhanced messages and/or cellular calls. Similar to the previous display, the message contains a time/date stamp, and a message. If the message is a phone number, you may press to make a call to that number.

Either of these displays appear until you press any key (except).

Signal
RCVD 1 Call
02:18P 12/05
FCN*:Msgs

This display appears when the phone has received one or more Voice Mail messages along with other enhanced features messages, and/or cellular calls. This display example shows that 1 cellular call has been received, as well as one or more enhanced feature messages as indicated by the "FCN*:Msgs" line.

To recall Voice Mail status messages, perform the following steps:

FCN*
1: CallBack 0
2: ShortMsg 0
3: V. Mail 3



1. Press and observe the following display:

NOTE: *The number to the right of "3: V.Mail" indicates the number of messages received since you last entered this particular menu. Each time you press "3" for Voice Mail, the V.Mail message number column resets to "zero" the next time you access this menu.*

FCN * 1-0000-
09:15A 12/05
01 URGENT!
2224444

FCN * 1-0000-
09:15A 12/05
03 Messages
2224444

FCN * 1-0000-
09:15A 12/05
2224444

2. Press  key to select Voice Mail. Observe the most recent Voice Mail status message appears on the display. (Depending on your cellular service provider, one of these 3 may messages appear.) This display holds only one Voice Mail message at a time, and therefore, overwrites the old message each time you display a new message. In the first example, the 01 indicates that one Voice Mail message awaits retrieval.
3. When you're done reading the message, press  to exit, or if the message is a phone number you wish to call, press .

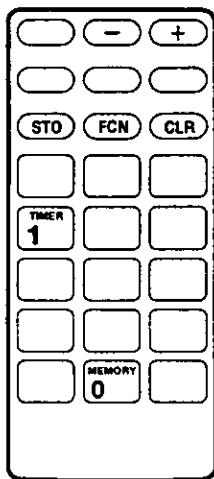

Call Length Timer (FCN 1)

Keypad Sequence:

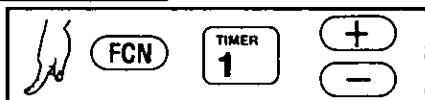

To reset:



Call Length Timer displays the length of time of single phone conversations, as well as the total amount of time the phone has been used. Five different timer modes are provided:

- **Last Timer** - shows elapsed time during most recent call; also shows "talk time" of the call in progress, updating once every ten seconds
- **Num 1 Timer** - shows total elapsed time of the first phone number (of two selectable numbers).
- **Num 2 Timer** - shows total elapsed time of the second phone number (of two selectable numbers).
- **Total Timer 1** - shows total elapsed time for all calls
- **Total Timer 2** - shows total elapsed time for all calls; resettable timer

NOTES:

- *Displays talk time of both making and receiving calls*
- *Only Timer 2 may be reset (not Timer 1)*
- *Last Timer does not display more than 99 minutes and 59 seconds, even with a call still in progress which exceeds this amount*
- *Elapsed timers reset to 000 hour and 00 minutes after reaching 999 hours and 59 minutes*
- *To cancel Timer Mode anytime, press (CLR) .*

To access timers, perform the following steps

FCN 1 ■■■■
Last Timer
12min 34sec
<+, - . Scroll >

- 1 Press FCN TIMER
1 Observe the **Last Timer** message appears on the display

FCN 1 ■■■■
NUM1 Timer
123hr 45min
<+, - : Scroll >

- 2 Press + to select NUM 1 Timer

FCN 1 ■■■■
NUM2 Timer
234hr 56min
<+, - . Scroll >

- 3 Press + again to select NUM 2 Timer (if applicable)

FCN 1 ■■■■
Total Timer 1
50hr 25min
<+, - Scroll >

- 4 Press + again to select Total Timer 1

FCN 1 ■■■■
Total Timer 2
45hr 15min
<+, - or 0 >

- 5 Press + again to select Total Timer 2 (To reset, press MEMORY
0)

FCN 1 ■■■■
Total Timer 2
Reset
< STD . Reset >

- 6 Press STD

FCN 1 ▬▬▬▬
 Total Timer 2
 000hr 00min
 Reset

- The phone automatically exits this mode after three seconds.

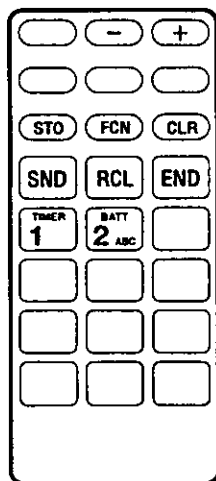

Battery (FCN 2)

Battery Level Indicator (Handheld Use Only)

Keypad Sequence:

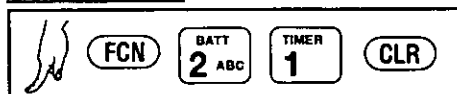

Battery Level Indicator checks the remaining battery pack power. Battery power level displays in 4 bars between E (empty) and F (full).

- Press **FCN** **BATT 2 ABC** **TIMER 1**.
- Observe the display shows black bars to indicate the remaining battery power level.
- To exit this mode, press **CLR**.

FCN 21 ▬▬▬▬
 Batt Meter
 E ■■■□ F
 < CLR : Exit >

Pace Beep

Keypad Sequence

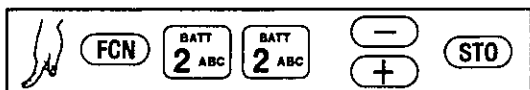

Pace Beep sounds a short tone once every minute during a conversation to help you keep track of the length of your call

1 Press **FCN** **BATT 2 ABC** **BATT 2 ABC**

FCN 22 ———
Pace Beep
Off
< +, - or STO >

2 Observe the display shows the current setting

FCN 22 ———
Pace Beep
On
< +, - or STO >

3 Press **(+)** or **(-)** to toggle the selection **On** or **Off**

FCN 22 ———
Pace Beep
On
Set

4 When the desired setting appears, press **(STO)**

5 The phone automatically exits this mode after three seconds

Low Battery Alarm

**Low Battery
Charge
Your
Battery!**

When battery power level reaches the "zero" bar (no bars filled), the display flashes the **Low Battery** warning message and sounds a one-second high tone every 6 seconds. If this occurs, immediately power the phone OFF to reduce battery power loss any further. Otherwise, the battery may fully discharge (zero bars) and the phone automatically power OFF and will not be capable of performing any normal functions, including power up.

If you don't have a spare battery pack, recharge the battery (See page 2-5). However, if a spare battery is available, remove the battery pack and replace it with the spare.

NOTE: *When the Low Battery indicator tones sounds, you can replace the battery with your fully charged spare without interrupting your call in progress, as long as you exchange it within a four-second period or less.*

Security (FCN 3)

Lock

CAUTION: *Be sure to obtain the proper unlock code before activating any lock functions!*

Keypad Sequence:



Lock feature allows you to electronically "lock" the phone to limit others from making and receiving unauthorized calls. Five lock types are provided:

- **UNLOCK** - No restrictions
- **DIAL LOCK** - Calls may not be dialed directly, but may be made from phone memory (00 to 99), or by redialing the last call made from memory.
- **SEND LOCK** - No calls may be made, but calls may be received
- **FULL LOCK** - No calls may be made, or received
- **RECEIVE LOCK** - Calls may be made, but not received.

If any of these lock features are active, your phone indicates the selection on the display immediately after you power ON.

Regardless of the lock setting, (except Theft Lock, see page 3-61) you may still make emergency calls such as 911 (if available in your area). However, emergency numbers are normally programmed by your dealer. Therefore, consult your dealer for emergency number configurations.

NOTES:

- To get unlimited access to your phone, "unlock" your phone.
- The default lock code for your phone is factory set to **0000**.
- To set a lock code, see page 3-67.
- If you enter an incorrect lock code, the phone automatically exits the lock mode and returns to the normal operating mode.

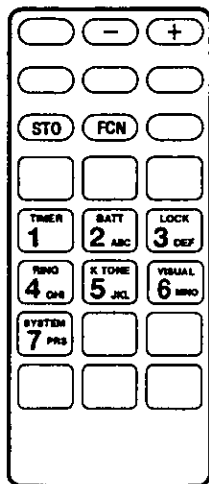

Signal 
Full Lock
08:00 AM
Dec 05

To select a Lock setting:

FCN 31
Lock Code?

1. Press **FCN** **LOCK 3 DEF** **TIMER 1**.
2. Enter your lock code and observe the display shows the current lock setting.

FCN 31
Lock Level
Recv Lock
< +, - or STO >

3. Press **+** or **-** to toggle through the various possible selections—**Unlock, Dial Lock, Send Lock, Full Lock, and Recv Lock.**

FCN 31
Lock Level
Recv Lock
Set

4. When the desired setting appears, press **STO**.
5. The phone automatically exits this mode after three seconds.

Dialing Digits Restriction

Keypad Sequence:



Signal
Dial Limit
08:00 AM
Dec 05

Dialing Digits Restriction feature limits the maximum number of digits (between 1 and 31) which may be successfully entered into the phone. For example, if setting the maximum number of digits to seven, long distance calls are not possible since greater than seven digits are required when making a long distance call. Emergency numbers, however, may still be called regardless of the limit setting.

FCN 32 -----
Lock Code?

If attempting to make a call which exceeds the restricted digits, a **Dial Limit** message appears for three seconds.

FCN 32 -----
Dial Limit
None
< +, - or STO >

1. To set the digit dialing limit, press **FCN** **3** **LOCK** **2** **BAFF** and enter your lock code.
2. With no dial limit currently set, the message "**None**" appears on the display. However, if a Dial Limit is set, the message "**Select**" appears.
3. Press **+** or **-** to toggle through these two possible selections--None or Select.

FCN 32 -----
Dial Limit
Select
< +, - or STO >

4. To leave the Dial Limit set to none, press **STO** with **None** selected on the display, and exit this mode by pressing **CLR**.
5. With **Select**, press **STO**. Observe the current Dial Limit appears on the display.

FCN 32 -----
Dial Limit
12 digits
< digits, STO >

6. Enter the desired digits between 1 and 31.
7. Press **STO** again to store the change to memory.
8. The phone automatically exits this mode after three seconds.

FCN 32 -----
Dial Limit
12 digits
Set

Memory Secret

Keypad Sequence:

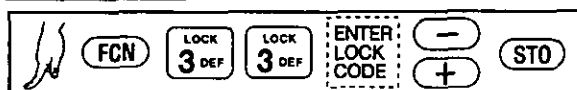

Memory Secret function restricts access to memory content using three different settings:

- **Open** - Memory accessed and data stored freely
- **Read Only** - Memory may be read, but data may not be revised, or new data stored
- **Close** - Memory may not be accessed (except for Scratch Pad and Last Number memory).

If attempting to access memory with Read Only or Memory Close active, a **Mem Secret** message appears for three seconds.

FCN 33-----
Lock Code?

1. To set the Memory Secret, press **FCN** **LOCK 3 DEF** **LOCK 3 DEF** and enter your lock code.

FCN 33-----
Mem Secret
Read Only
< +, - or STO >

2. Press **+** or **-** to toggle through the various possible selections—Open, Read Only, Close.
3. When the desired setting appears, press **STO** .

FCN 33-----
Mem Secret
Read Only
Set

4. The phone automatically exits this mode after three seconds.

Theft Lock

Keypad Sequence:



Theft Lock function allows totally disabling the phone to eliminate the possibility of unauthorized use. Theft Lock function may be set either ON or OFF. When ON, the **Theft Lock** message appears on the display immediately after powering ON. A theft tone "buzzer" will also sound for ten seconds.

To override the Theft Lock feature, enter your Theft or Lock code within ten seconds of the **Theft Lock** message appearing on the display. If you miss the ten-second window, power the phone OFF and then ON and try again.

In handsfree/car mount use only, the phone will automatically proceed in making a call (from a formerly-entered number) after the ten second period. This may be helpful as an alarm to you if you are away from your phone and an unauthorized person attempts to use your phone. Simply enter the number where you can be reached and the phone will automatically place a call to that number if an attempt is made to use your phone.

When you or the called party answers, an Intercept tone begins and continues for 50 seconds after which the call terminates. In addition, if Horn Alert feature is active, the horn or headlights will activate after the initial ten-second period.

NOTES:

- Set the Theft Code (see page 3-66) before setting the Theft Lock Condition.
- If Dial Lock, Send Lock, Full Lock, or Receive Lock is active, the display shows the particular lock setting after overriding Theft Lock.
- With Theft Lock active, emergency override is disabled. In other words, emergency calls cannot be made when Theft Lock is active.

1. Set the Theft Lock code number according to the procedures described on page 3-66.

FCN 34
Lock Code?

2. To activate Theft Lock, press **FCN** **LOCK 3 DEF** **RING 4 ON** and enter your lock code. Observe the current setting appears on the display.

FCN 34
Theft Lock
On
< +, - or STO >

3. Press **+** or **-** to toggle through the two possible selections—On or Off. To activate, select On.

FCN 34
Tel No?
2224444

4. For car mount use only, enter 3 (or more) digits as a desired forwarding phone number.

FCN 34
Theft Lock
On
Set

5. Press **STO** to save the setting in memory.
6. The phone automatically exits this mode after three seconds.

NOTES:

- If an alarm sounds when Theft Lock is displayed, stop the tone by powering the phone OFF and then ON again and re-entering your lock code.
- You can make a call using the pre-determined number, even if it exceeds the Dialing Digits Restriction feature (see page 3-58).

Master Function

Keypad Sequence:

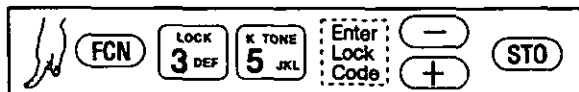

Master Function allows setting levels and conditions of functions such as volume level, ring tone, and numerous others as "default" settings each time you power ON. Master Function provides three different option settings:

FCN 35-----
Master FCN
Set
< +, - or STO >

- **Set** - Current function settings are stored to memory as "master" function
- **Reset** - Current function settings change to agree with master function as set with specific function set
- **Clear** - Each function is set to center level, Off, or original factory default value (See Table 3.3).

FCN 35-----
Master FCN
Reset
< +, - or STO >

1. To select desired settings, press **FCN** **LOCK 3 DEF** **K TONE 5 JKL** and enter your lock code. Observe the current setting appears on the display.

2. Press **(+)** or **(-)** to toggle through the various possible selections—**Set**, **Reset**, and **Clear**. Reset will not appear on the display unless master function has previously been set.

FCN 35-----
Master FCN
Clear
< +, - or STO >





























NOTE: See Table 3.3 for a complete listing of default settings selected when you choose "Clear".

FCN 35-----
Master FCN

Cleared

3. When the desired setting appears, press **STO** to save in memory.
4. The phone automatically exits this mode after three seconds.

Table 3.3
Function "Clear" Default Setting List

FUNCTION NAME	KEYPAD SEQUENCE	DEFAULT SETTINGS
Total Timer 2*	FCN 	Reset
Pace Beep	FCN  	Off
Dialing Digits Restriction	FCN  	None
Memory Secret	FCN  	Memory open
Theft Lock Pre-determined phone number	FCN  	Off Null
Theft Code	FCN  	None
Volume control - Ring volume	FCN   + or -	Center level (level 3)
- Earpiece volume	+ or -	Center level (level 3)
- Key volume	+ or -	Center level (level 3)
Setting ring tone	FCN  	Number 1 Standard tone Number 2 Standard tone
Escalating Ring Tone	FCN  	Off
Auto Answer	FCN  	Off
Setting keytone on/off	FCN 	On (Keytone ON)
Backlight control	FCN  	On
Setting backlight color	FCN  	Green
Own number display	FCN  	Phone number (No 1)
System select	FCN  	Normal mode

FUNCTION NAME	KEYPAD SEQUENCE	DEFAULT SETTINGS
Automatic recall * - Delay Time - Phone number to be recalled	FCN 8 CLOCK TUV 2 BATT ABC	Off 00 minutes Null
Automatic Power On (alarm) - Setting Time	FCN 8 CLOCK TUV 3 LOCK DEF	Off 12:00 AM
Automatic Power OFF - Setting Time	FCN 8 CLOCK TUV 4 RING OH	Off 12:00 AM
Power-off Timer after Ignition Off	FCN 8 CLOCK TUV 5 R. TONE JKL	10 Hours
Dial receive	FCN 9 OPTION WXY 1 TIMER	Off
Horn alert	FCN 9 OPTION WXY 2 BATT ABC	Off

*Total timer 2 and Automatic Recall may not be stored to memory as part of Master Function.

How to Set Theft Code

Keypad Sequence:

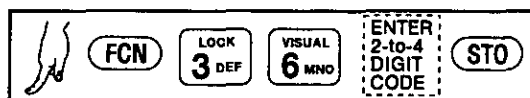

Theft Codes are usually any two-to-four digit number combinations of your choice, including the * and # characters. Select a number which is easy for you to remember, yet not obvious to someone else.

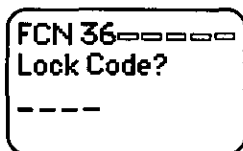

1. To enter a new Theft Code number, press (FCN) (LOCK 3 DEF) (VISUAL 6 MNO) and enter your lock code. Observe the current setting appears on the display.

NOTE: To escape from this mode without changing the theft code, press (CLR).

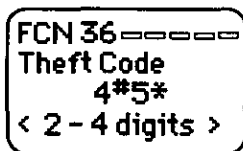

2. Enter the desired two-to-four digit number, including * and # characters. If you make a mistake while entering the digits, briefly press (CLR) to backspace over the incorrect digit.

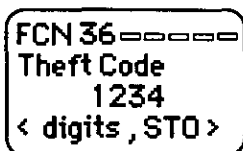

3. Press (STO) to save the code to memory.

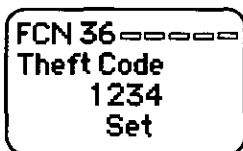

4. The phone automatically exits this mode after three seconds.

How to Set New Lock Code

Keypad Sequence:

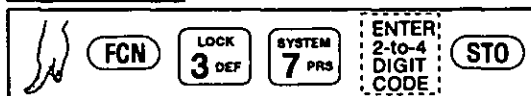

The Lock Code for your phone is factory set to 0000. However, you may wish to change this code to any two-to-four digit number combinations of your choice, including the * and # characters. Select a number which is easy for you to remember, yet not obvious to someone else.

FCN 37 0000
Lock Code?

1. To set a new Lock Code number, press **FCN** **LOCK 3 DEF** **SYSTEM 7 PRS** and enter your existing lock code (0000 if new). Observe the current setting appears on the display.

NOTE: To escape from this mode without changing the Lock code, press **CLR**.

FCN 37 0000
New Code
9012
< digits , STO >

2. Enter the desired two-to-four digit number, including * and # characters. If you make a mistake while entering the digits, briefly press **CLR** to backspace over the incorrect digit.

FCN 37 0000
New Code
0000
< 2 - 4 digits >

3. Press **STO** to save the code to memory.

FCN 37 0000
New Code
9012
Set

4. The phone automatically exits this mode after three seconds.

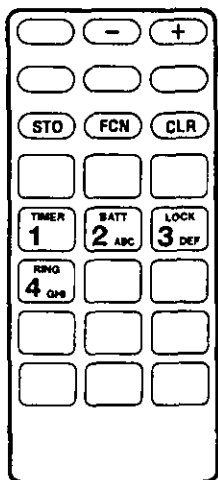

Ringing (FCN 4)

Ring Volume Control

Keypad Sequence:

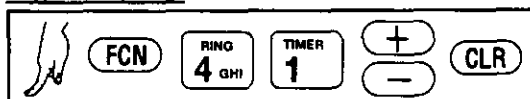

1. To adjust the ringing volume, first press **FCN** **RING 4 GH** **TIMER 1**.

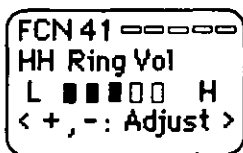

2. Adjust the ringing volume up or down by pressing **(+)** or **(-)** respectively and listening for the sample tone. The number of black bars indicate the present volume level (L for LOW, and H for HIGH). In handheld use if you select the lowest setting, the ring tone is silenced completely.

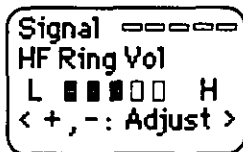

3. In handsfree/car mount use with the handset on the cradle, you'll hear the ring tone from the handsfree speaker, even at the lowest volume settings.
4. To save and exit this mode, press **(CLR)**.

Setting Ring Tone

Keypad Sequence

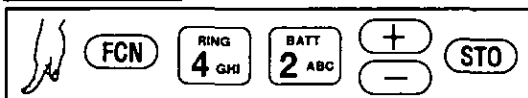

This feature allows selecting among three Ring Tone types

- **Standard** - Normal phone ring
- **Dual** - Two rings every three seconds
- **Special** - Long, widely separated rings

FCN 42 0000
Ring Tone
Standard
< +, - or STO >

- 1 To select the ring tone, press
- 2 Observe the current setting appears on the display, and the phone sounds a sample tone

FCN 42 0000
Ring Tone
Dual
< +, - or STO >

- 3 Use the or keys to scroll through the possible settings--Standard, Dual, and Special
- 4 When the desired choice appears on the display, press

FCN 42 0000
Ring Tone
Special
< +, - or STO >

- 5 The phone automatically exits this mode after 3 seconds

FCN 42 0000
Ring Tone
Standard
Set

NOTE: *You can select a different ring tone for two different phone numbers if your phone is programmed for two numbers (see page 3-76) Simply select the desired ring tone when actively "logged-on" to the proper number*

Escalating Ring Tone (Handheld Use Only)

Keypad Sequence

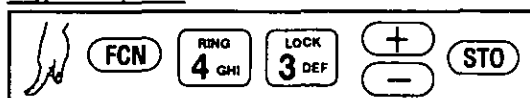

This feature allows selecting a ring tone which escalates from the currently selected level to the loudest level as it progresses with each ring

FCN 43-----
Escalating
Off
< + , - or STO >

- 1 To select the ring tone, press **FCN** **RING 4 GHI** **LOCK 3 DEF**
- 2 Observe the current setting appears on the display, and the phone sounds a sample tone

FCN 43-----
Escalating
On
< + , - or STO >

- 3 Use the **(+)** or **(-)** keys to scroll through the possible settings—Off and On To activate, select "On"

FCN 43-----
Escalating
On
Set

4. When the desired choice appears on the display, press **(STO)**

FCN 43-----
Escalating
On
< + , - or STO >

- 5 The phone automatically exits this mode after three seconds

NOTE: If the Ring Tone is completely silenced (See page 3-68), Escalating Ring Tone will not be active

Auto Answer (Car Mount Use Only)

Keypad Sequence:



Auto Answer allows answering a phone call automatically 6 seconds after the ring tone begins without lifting the handset, or pressing any key to answer the call.

FCN 44- - - - -
Auto Ans.
Off
< + , - or STO >

1. To select the Auto Answer, press **FCN** **4** **4** .
2. Observe the current setting appears on the display.

FCN 44- - - - -
Auto Ans.
On
< + , - or STO >

3. Use the **+** or **-** keys to scroll through the possible settings—Off and On. To activate, select "On".

FCN 44- - - - -
Auto Ans.
On
Set

4. When the desired choice appears on the display, press **STO** .
5. The phone automatically exits this mode after three seconds.

NOTES:

- This feature does not function in handheld use.
- If Call Receive and Auto Answer are both set to ON, Auto Answer will not function.
- This feature will not function when the ignition is set to OFF.
- The selected ON/OFF setting is saved in memory as the default setting whenever turning the phone power OFF and ON again.

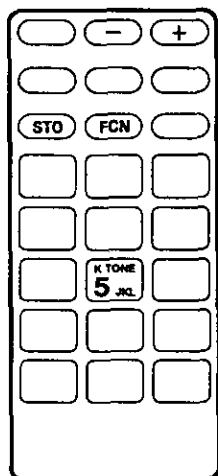

Keytones On/Off (FCN 5)

Keypad Sequence:

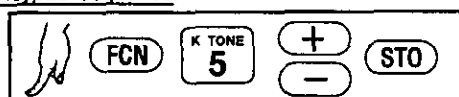

This feature allows choosing to silence the keytones (DTMF tones produced when pressing any key). Additionally when active, the phone will not transmit the DTMF. However, recalling and sending DTMF tones from memory during conversation is still possible.

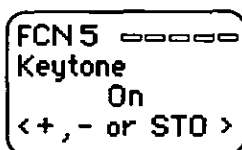

1. To select the Keytone feature, press **FCN** **K TONE 5**.
2. Observe the current setting appears on the display.

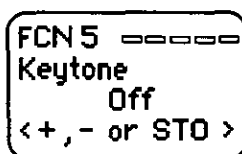

3. Use the **(+)** or **(-)** keys to scroll through the possible choices—Off and On. To silence the keytones, select "Off".

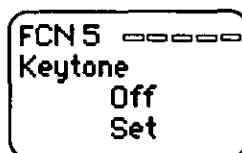

4. When the desired choice appears on the display, press **STO**.
5. The phone automatically exits this mode after three seconds.

NOTES:

- The selected setting is saved in memory as the default setting whenever turning the phone power OFF and ON.
- Keytone volume may still be adjusted, even if keytone function is OFF.

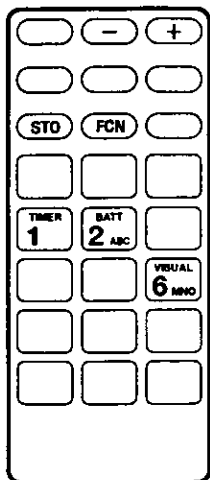

Display (FCN 6)

Wake-up Display Program

Keypad Sequence:

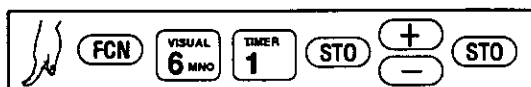

Wake-up Display Program allows entering "customized" messages on the third line of the wake-up display message which appears immediately following power ON. However, the first and second lines always displays one of the following messages:

Good Morning! (if between 12:00 AM and 11:59 AM)

OR

Good Afternoon! (if between 12:00 PM and 11:59 PM)

Good
Morning!

000-123-4567

1. To select the Wake-Up Display feature, press **FCN**

VISUAL 6 MNO **TIMER 1** . Observe the current setting appears on the display.

FCN 61 **A**
Wake Up Disp

< STO : Enter >

2. To enter (or change) a third-line message, press **STO** . Note a cursor block appears.

3. Use the procedures described on page 3-14 (alphanumeric input) to enter the desired message up to 12 characters.

FCN 61 **o o o o o**
Wake Up Disp
John Doe
Set

4. When the desired choice appears on the display, press **STO** .

5. The phone automatically exits this mode after three seconds.

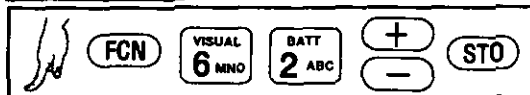

Backlight Control (Car Mount/DC Adaptor Use Only)

Keypad Sequence:

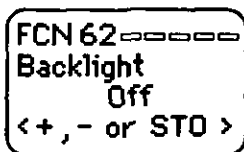

Under normal operation in handheld use (or in vehicle with the ignition OFF), the handset backlight illuminates the display and keypad for 7 seconds every time you power ON, or press any key. With this feature, however, you may choose to have the backlight remain on continuously if so desired.



1. To select the Backlight Control feature, press **FCN**  . Observe the current setting appears on the display.

2. Observe the current setting appears on the display.

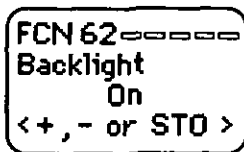

3. Use the **+** or **-** keys to scroll through the possible choices—**Off** and **On**. To keep the backlight on continuously, select **On**.

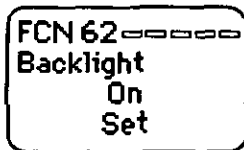

4. When the desired choice appears on the display, press **STO**.
5. The phone automatically exits this mode after three seconds.

NOTE: In car mount use even when selecting backlight "On", the backlighting illuminates for only 7 seconds when ignition is OFF.

Setting Backlight Color

Keypad Sequence:

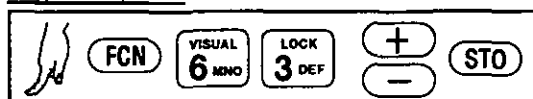

This feature allows selecting the backlight color for the display—amber or green.

FCN 63-----
Dspl Color
Green
<+, - or STO >

1. To select the Backlight Color feature, press **FCN** **VISUAL 6 MNO** **LOCK 3 DEF**. Observe the current setting appears on the display.

2. Observe the current setting appears on the display.

FCN 63-----
Dspl Color
Amber
<+, - or STO >

3. Use the **+** or **-** keys to scroll through the possible choices—Green and Amber.

FCN 63-----
Dspl Color
Amber
Set

4. When the desired choice appears on the display, press **STO**.
5. The phone automatically exits this mode after three seconds.

NOTE:

- If using backlight while receiving a call, the "Ringing" message flashes in the alternate color.
- The selected setting is saved in memory as the default setting whenever powering the phone OFF and ON again.

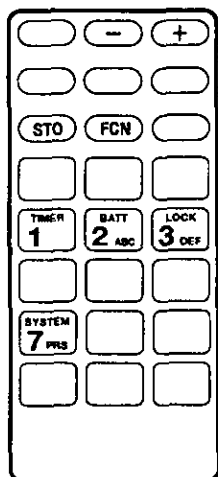

System (FCN 7)

Own Number Display

Keypad Sequence:

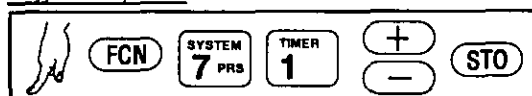

This feature allows selecting between the two different numbers from which your phone may operate (if so programmed by your authorized dealer). Switching between the two numbers while a call is in progress is not possible.

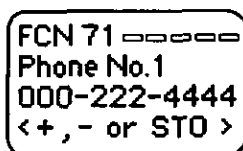

1. To select the number, press **FCN** **SYSTEM 7 PRS** **TIMER 1**. Observe the currently-selected phone number appears on the display.

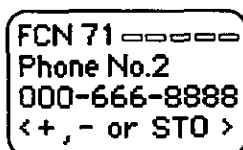

2. Use the **(+)** or **(-)** keys to toggle between the two possible choices.

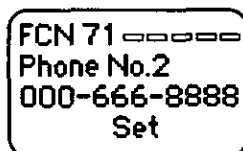

3. When the desired number appears on the display, press **(STO)**.
4. The phone automatically exits this mode after three seconds.

A/B System Select

Keypad Sequence:

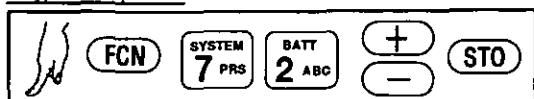

In most cities where cellular service is available, two network providers exist—an "A" carrier and a "B" carrier. At the time of installation, your phone was programmed to access the cellular service provider of your choice. Therefore, after powering on your phone, it automatically accesses service from this **preferred** cellular service. Additionally with A/B system selection feature, your phone allows alternating between two cellular system service providers. This flexibility ensures optimum cellular service.

When your phone number is assigned, you or your dealer selects and registers with either of these two carriers as your **preferred** system:

- Wireline Carrier (W/L)
- Non-Wireline Carrier (N-W/L)

The W/L Carrier system (also called system B), is the conventional telephone service and cellular provider in the area. The N-W/L system (also called System A) is the competing cellular service provider.

After power up, three different displays inform you under which system your phone is presently operating:

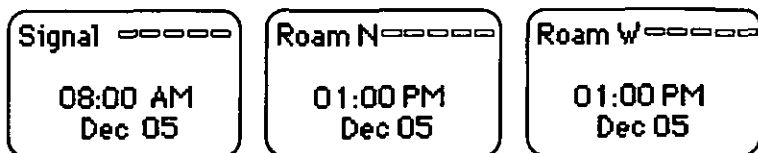

"**Signal**" appears when your phone is operating within the "home" system.

"**Roam N**" appears when your phone is operating on the N-W/L system, outside your home system.

"Roam W" appears when your phone is operating on the W/L system, outside your home system (both preferred and non-preferred system).

When your phone locks onto a "non-preferred system, generally you will not have service unless you've previously registered or have made a roaming agreement with the non-preferred system. Your dealer can program your phone for both systems using the Two Selectable Phone Number feature (see page 3-76).

Some "home" systems already have an established roaming agreement. This means you can place a call from your phone using the visiting system and your account will automatically be billed for the service.

NOTE: *When you're outside of the "home" system, you are not able to receive calls unless the calling party dials the "roamer access number" of the initial system. To receive calls in that area, consult a representative of the Carrier for that location and inform them of expected received calls and determine the dialing method. Also "Follow Me Roaming" and "Transparent Calls" features are now available with most carriers.*

After your dealer programs your phone, you may select one of the following system choices using A/B System Select feature:

- **Normal Mode** - The phone automatically selects between either N-W/L or W/L depending on where you are currently located. If inside the service area of the preferred system, it continues using this system. If not, the phone checks to see if you're inside the service area of the non-preferred system and uses this system instead (Roam display ON). Periodically, the phone will again check to see if you have returned to the service area of the preferred system, and if so, returns to that network (Roam display OFF).

• **N-W/L System**

Only Mode -

The phone selects N-W/L system only. (Some network service may not be available on the N-W/L system if your phone is not properly registered with this system.)

• **W/L System**

Only Mode -

The phone selects W/L system only. (Some network service may not be available on the W/L system if your phone is not properly registered with this system.)

• **Home System**

Only Mode -

The phone selects your home system only

FCN 72-----
A/B Select
Normal
< +, - or STO >

1. To Select the desired mode, press **FCN** **7** **2** . Observe the currently-selected mode appears on the display.

FCN 72-----
A/B Select
N-w/L Sys
< +, - or STO >

2. Use the **+** or **-** keys to toggle between the four possible choices—Normal, N-W/L Sys, W/L Sys, and Home Sys.

3. When the desired mode appears on the display, press **STO** .

FCN 72-----
A/B Select
w/L Sys
< +, - or STO >

4. The phone automatically exits this mode after three seconds.

NOTE:

- The system setting you select is retained in memory even after powering the phone OFF and then ON, except:
 - if you have two phone numbers programmed in the phone and switch between them; A/B setting defaults to Normal Mode.
 - If so programmed by your authorized dealer, the phone also selects Normal Mode when powering the handset OFF and then ON.

FCN 72-----
A/B Select
Home Sys
< +, - or STO >

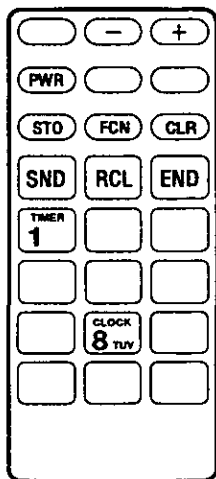

Clock (FCN 8)

Setting the Clock

Keypad Sequence:

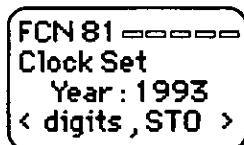
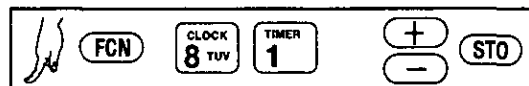

1. Press **FCN** **CLOCK 8 TUV** **TIMER 1**. Observe the currently-selected year appears on the display.

2. Enter the desired digits for the year between now and 2099. If you make a mistake during entry, press **CLR**.

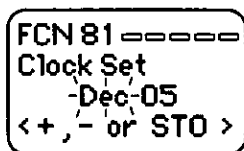

3. Press **STO** to save the year entry and move on to setting the month.

4. Use the **+** or **-** keys to scroll through the months of the year until the present month appears.

5. Press **STO** to save the month entry and move on to setting the date.

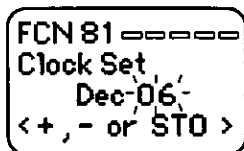

6. Use the **+** or **-** keys to scroll through the days of the month until the present day appears.

7. Press **STO** to save the day entry and move on to setting the hour.

FCN 81
Clock Set
-08:00 AM
< + , - or STO >

8. Use the \oplus or \ominus keys to scroll through the hours of the day until the present hour appears. Time can be set between 12:00 and 11:59.
9. Press STO to save the hours entry and move on to setting the minutes:

FCN 81
Clock Set
09:45 AM
< + , - or STO >

10. Use the \oplus or \ominus keys to scroll through the minutes of the hour until the present time appears.

FCN 81
Clock Set
09:45 PM
< + , - or STO >

11. Press STO to save the minutes entry and move on to setting AM or PM.
12. Use the \oplus or \ominus keys to scroll through the two available settings--AM or PM.

FCN 81
Clock Set
09:45 PM
Set

13. Press STO to store the time setting.
14. The phone automatically exits this mode after three seconds.

Automatic Recall (Handheld Use Only)

Keypad Sequence



Signal ■■■■
Auto RCL
2224444

This feature provides a programmable 99-minute timer/alarm to remind you to place a specific call. When the alarm sounds, the specified number appears on the display and a corresponding buzzer sounds for one minute.

To silence the alarm, press any key except **PWR**. To call the particular number, simply press **SND**.

Signal ■■■■
2224444

1 To program Auto Recall, first enter the digits of the desired number you're calling.

2 Press **FCN** **CLOCK 8 TUV** **BATT 2 ABC**. Observe the currently-selected on/off status appears on the display.

FCN 82 ■■■■
Auto RCL
On
< +, - or STO >

3 Use the **+** or **-** keys to toggle between the two choices—On or Off.

4 When the desired choice appears on the display, press **STO**.

FCN 82 ■■■■
Auto RCL
Delay · 00 min
< digits, STO >

5 When choosing ON, enter the delay time (between 1 and 99 minutes) for the timer to activate. If you make a mistake during entry, use **CLR** key to correct.

FCN 82 ■■■■
Tel No?
2224444

6 Press **STO** to save to memory. The message **Tel No?** appears on the display to allow final verification of the phone number. If necessary, you may alter the number at this point. After confirming the number, press **STO**.

FCN 82 
AutoRCL
On
Set

7. The phone automatically exits this mode after three seconds.

NOTE:

- If you press **(STO)** when OFF message appears on the display, the phone automatically exits this mode after three seconds.
- If you turn phone power OFF before the set time arrives, the phone will power ON automatically when the set time arrives, the buzzer will sound for one minute, and the previously set number will appear on the display.
- If a call is already in process when the set time arrives, AUTO RCL will not activate until you complete the call.
- To make a call using the number stored in Auto Recall, make sure the phone is not in Dial Lock, Send Lock, or Full Lock (see page 3-57) modes.
- This feature cancels automatically when changing from handheld use to car mount or DC Adaptor use.

Auto Power On (Alarm)

Keypad Sequence

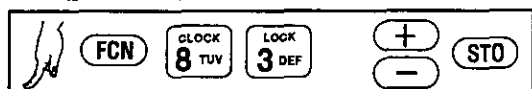

This feature provides a programmable timer/alarm which automatically powers the phone ON at a specified time. In addition, a tone sounds for one minute when the selected time arrives. To silence the tone, press any key except

(PWR)

For this feature to work properly, the phone must be powered OFF by pressing the (PWR) key, or by Auto Power Off feature (see page 3-86).

- 1 Make sure Theft Lock feature is not active
- 2 Press (FCN) (CLOCK 8 TUV) (LOCK 3 DEF). Observe the currently-selected on/off status appears on the display
- 3 Use the (+) or (-) keys to toggle between the two choices—On or Off
- 4 When "On" appears, press (STO) to save and move on to the "set hours" mode
- 5 Use the (+) or (-) keys to scroll through the hours of the day until the desired hour appears. Time can be set between 12:00 and 11:59
- 6 Press (STO) to save the hours entry and move on to setting minutes
- 7 Use the (+) or (-) keys to scroll through the minutes of the hour until the desired time appears

FCN 83 - - - - -
Auto On
On
< +, - or STO >

FCN 83 - - - - -
Auto On
at 09:00 AM
< +, - or STO >

FCN 83 - - - - -
Auto On
at 10:00 AM
< +, - or STO >

NOTE: If you press and hold the (+) or (-) keys, the display will scroll in 10-minute increments.

FCN 83 -----
Auto On
at 10:20 AM
< +, - or STO >

8. Press (STO) to save the minutes entry and move on to setting AM or PM.
9. Use the (+) or (-) keys to scroll through the two available settings—AM or PM.

FCN 83 -----
Auto On
at 10:20 PM
Set

10. Press (STO) to save the time setting.
11. The phone automatically exits this mode after three seconds.

NOTES:

- If the phone is already powered ON when the alarm time arrives, the tone will still sound for one minute.
- This feature, if active, remains in effect even after powering the phone OFF. If the settings remain unchanged, the phone will power up at the same time the following day.
- This feature will not function if Theft Lock is active.

Auto Power Off (Handheld Use Only)

Keypad Sequence:

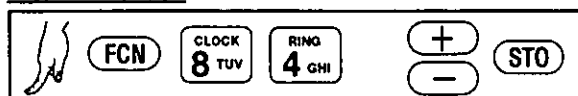

This feature provides a programmable timer/alarm which automatically powers the phone OFF at a specified time.

FCN 84 - - - - -
Auto Off
On
< +, - or STO >

1. Press **FCN** **CLOCK 8 TUV** **RING 4 GHI**. Observe the currently-selected on/off status appears on the display.
2. Use the **+** or **-** keys to toggle between the two choices—On or Off.
3. When "On" appears, press **STO** to save and move on to the "set hours" mode.

FCN 84 - - - - -
Auto Off
at 09:00 AM
< +, - or STO >



4. Use the **+** or **-** keys to scroll through the hours of the day until the desired hour appears. Time can be set between 12:00 and 11:59.
5. Press **STO** to save the hours entry and move on to setting minutes.

FCN 84 - - - - -
Auto Off
at 10:00 AM
< +, - or STO >

6. Use the **+** or **-** keys to scroll through the minutes of the hour until the desired time appears.
7. Press **STO** to save the minutes entry and move on to setting AM or PM.

NOTE: If you press and hold the **+** or **-** keys, the display will scroll in 10-minute increments.

FCN 84 
Auto Off
at 10:20 AM
< +, - or STO >

8. Use the  or  keys to scroll through the two available settings—AM or PM.

9. Press  to save the time setting.

FCN 84 
Auto Off
at 10:20 PM
Set

10. The phone automatically exits this mode after three seconds.

NOTES:

- If the phone is in use when the alarm time arrives, power goes OFF automatically after you complete the call.
- This feature does not remain in effect after set-time activation. Reset the off time for each new power OFF instance.
- This function cancel automatically when changing from handheld use to car mount or DC Adaptor use.

Safety Timer (Car Mount Use Only)

Keypad Sequence:

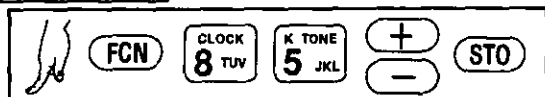

This feature, when used in conjunction with Alert and Call Receive features, provides a programmable power OFF timer after turning the vehicle ignition switch to OFF from ON or ACCESSORY position. In other words, the phone will power off automatically after a specified time to insure total power down.

FCN 85 ----
Safety Timer
10 hrs
< +, - or STO >

1. To set power-off time, press **FCN** **CLOCK 8 TUV** **K TONE 5 JKL**. Observe the currently-selected timer setting appears on the display.

FCN 85 ----
Safety Timer
05 hrs
< +, - or STO >

2. Use the **+** or **-** keys to toggle between the four choices—10, 15, 1, or .5 hours.

FCN 85 ----
Safety Timer
05 hrs
Set

3. When the desired time appears, press **STO**.
4. The phone automatically exits this mode after three seconds.

NOTES:

- If you turn the ignition switch to OFF position with a call in progress, the timer will not start until you complete the call.
- The timer automatically cancels when:
 - powering the phone OFF using the **PWR** key
 - changing from vehicle use to handheld or DC Adaptor use
 - turning the vehicle ignition to OFF and then ON again.
- In case time has elapsed during ringing or conversation, power goes off automatically when the call is terminated.

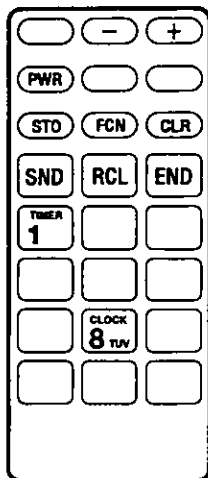

Vehicle Use Options (FCN 9)

Call Receive

Keypad Sequence:

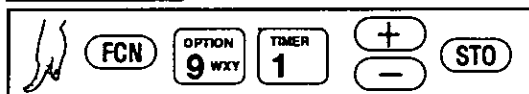

This feature provides a method of taking calls while you are away from your phone. The phone sends the caller two short beeps, 3 times to request entry of their number and stores the number in memory along with time/date stamp.

The phone is capable of storing up to ten separate numbers made up of 32 digits each (maximum). After storing ten numbers, the first message is erased to make room for the eleventh message and so on with successive calls.

Call Receive feature may not be activated simultaneously with Horn Alert (see page 3-91).

To activate Call Receive:

1. With the ignition switch ON, press **FCN** **OPTION 9 WXY** **TIMER 1**.
Observe the currently-selected mode appears on the display.
2. Use the **+** or **-** keys to choose between the choices—**On** or **Off**.
3. When **On** appears on the display, press **STO**.
4. The phone automatically exits this mode after three seconds.

FCN 91 ———
Call Receive
On
< +, - or STO >

FCN 91 ———
Call Receive
Off
Set

To use Call Receive feature:

Signal ○○○○
Call Receive
08:00 AM
Dec 05

5. Return the ignition switch to normal OFF or LOCK position. (Call Receive functions with ignition ON, also.)

MUTE ○○○○
Call Receive
08:00 AM
Dec 05

6. Six seconds after an incoming call begins, the Receive Call feature will answer the call and prompt the caller to enter their return phone number (up to 32 digits) by sounding two beeps 3 times. The caller sends their phone number by conventional touch-tone (DTMF) up to 32 digits. If the phone receives more than 32 digits, it automatically terminates the call from that point. The display shows the numbers corresponding to the DTMF tones from the caller.

MUTE ○○○○
Call Receive
012345678

7. Once the calling party is finished, the caller's phone number and time stamp are stored in memory. The display shows the number of calls received (up to 10) along with a time/date stamp.
8. To recall this information, power ON the phone and press RCL #. Note the caller's phone number, time stamp of the last received call, and the total number of unanswered calls appear on the display.

Signal ○○○○
RCVD Call
09:40 AM 12th
1 Call

9. Scroll the last ten numbers using the + or - keys.

RCL # ○○○○
08:00A 12/05

NOTES:

- This feature, when active, remains in effect even after powering the phone OFF and then ON again.
- The phone powers OFF automatically when time has elapsed with the "Safety Timer" feature.
- When Full Lock or Receive Lock features are active, power automatically goes OFF when the ignition switch is OFF.





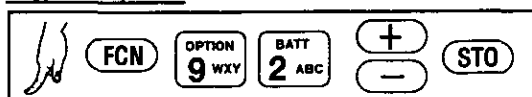

Alert Option (Horn)

Keypad Sequence:



When outside of your vehicle, Alert informs you of an incoming call by sounding the vehicle's horn or flashing the headlights once every three seconds for a total of 20 seconds. After 20 seconds, Alert stops and the phone continues to ring (an additional 45 seconds) with the conventional ringing tone and may be answered as normal.

To activate Alert:

1. With the ignition switch in the "ON" position, press **FCN** . Observe the currently-selected mode appears on the display.
  .
2. Use the **+**  or **-**  keys to choose between the choices--On or Off.
3. When "On" appears on the display, press **STO**  .
4. The phone automatically exits this mode after three seconds.

NOTES:

- Be sure Alert Kit (EB-J10262) installation procedures have been properly performed.
- Alert features will not operate with either Full Lock or Received Lock features active.
- With both Call Receive and Alert features set to active, Alert takes priority over Call Receive.
- Alert functions until Safety Timer expires or the ignition switch is turned ON.
- The feature automatically cancels when:
 - powering the phone OFF using the **PWR**  key
 - changing from handsfree/car mount use to handheld or DC Adaptor use
 - turning the ignition ON from the OFF position.

To use Alert:

5. Before leaving your vehicle, place the ignition switch in the OFF position.
6. When the phone receives an incoming call, it produces the normal ringing tone and repeatedly sounds the horn (or flashes the lights) for a total of 20 seconds.
7. To stop the sounding horn/flashing lights, answer the call, turn the ignition switch to ON, or wait 20 seconds for the Horn Alert to time-out. Even after the horn is silent, you can still answer the call during the continuing ringing tone.

Radio Mute Option (for Panasonic-Specified Car Audio Units Only)

This feature mutes a car radio when the phone begins ringing and will keep it muted during the conversation. When you complete the call, the radio is unmuted.

Contact your authorized dealer for installation and programming information.

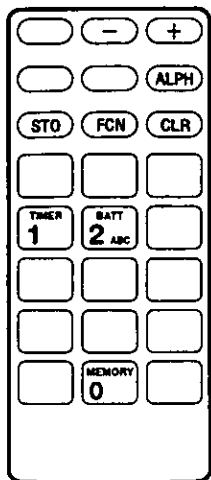

Memory (FCN 0)

Memory Check

Keypad Sequence:



Memory Check provides a convenient method of displaying the current amount of memory capacity, as well as the number of files being used. However, files may not be viewed individually in this mode.

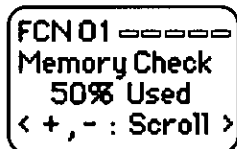

1. To check the memory amount, press **FCN** **MEMORY 0** **TIMER 1**. Observe the amount of memory (as a %) currently being used appears on the display.

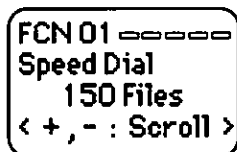

2. To check the current number of total files stored in memory, press **+**.
3. Press **CLR** to escape.

Creating/Deleting Group Label Program

Keypad Sequence:

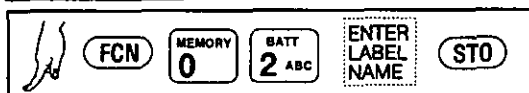

This function provides the method of creating up to 30 Group Labels, each up to 12 characters long.

To create a new label:

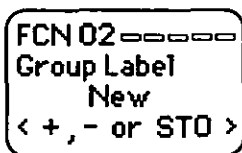

1. Press **FCN** **MEMORY 0** **BATT 2 ABC**.
2. Press **STO** and observe the cursor appears on the display.

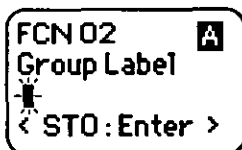

3. Enter the Group Label name using the Alphanumeric input procedures described previously on page 3-14. Additionally, you may use words from the Word List stored in your phone's memory (see page 3-17 for details).



4. Press **STO** to save the entry.

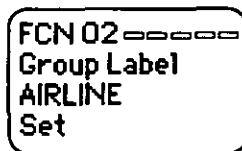

5. The phone automatically exits this mode after three seconds.

To delete a Group Label

NOTE: Make sure all files within the selected Group are deleted (or moved) before attempting to delete the Group Label

FCN 02 -----
Group Label
New
< +, - or STO >

6 Press **FCN** **MEMORY 0** **BATT 2 ABC**

7 Use the **(+)** or **(-)** keys to scroll through the currently existing Group Labels until you reach the label to be deleted

FCN 02 -----
Group Label
AIRLINE B █
< STO:Enter >

8 Press **(STO)**

9 Use the **(CLR)** key to delete the label

FCN 02 **A**
Group Label
█
< STO:Enter >

10. Again press **(STO)**

11 The phone automatically exits this mode after three seconds

Storing Names & Numbers

A

This appendix provides two typical examples of how to program and use Speed-dial Memory. The first example shows how to store a phone number(s) with a Name Tag. The second example shows how to group the two Name Tags underneath a specific Group Label.

Before attempting to practice with these examples, please first review, [How to Enter Alphanumeric Characters](#).

NOTE: Use the **(CLR)** key at anytime to escape from an operation.

EXAMPLE #1 - Storing A Name & Phone Number

Let's assume you have a friend named Joe Doe and you would like to store his name along with both his office and home phone number in your phone. To perform this task, follow these procedures:

Signal 

01:00 PM
Dec 05

1. Power ON the phone and wait for the wake-up display message to be replaced with the **Signal** or **Roam** indication.



- First we must enter the Name Tag for Joe's office, in this case **Joe Doe-office**. To do so, enter the Alphanumeric Input Mode by pressing (ALPH). Observe the current input display mode appears in the upper right-hand corner of the display.

- Press (FCN) to scroll between 3 possible input display modes:

- Uppercase letters
- Lowercase letters
- Numbers/symbols.

NOTE Refer to Table 3.1 (page 3-15) for a complete list of available input characters.

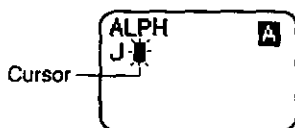

- For Joe's name, let's use both uppercase () and lowercase () letters. Starting with uppercase, press (+) or (-) to scroll sequentially through the characters one at a time until you reach "J". (For rapid scroll, press and hold the (+) / (-) keys.)

- Press (#) to enter the selected letter and automatically move the cursor over to the next column.

NOTE:

- To correct an entry mistake (or to simply move the cursor to the left), press (*) to move the cursor one space at a time to the left until the cursor is on top of the character in error.
- To delete characters one at a time, press (CLR). To delete the entire entry, press and hold (CLR) for about 1 second.

- Change to lowercase mode (press (FCN)) and continue scrolling through the letters until you reach the letter "o" and again press (#) .

7. Enter the letter "e" in a similar manner.

8. To enter a space between letters/words (or simply move the cursor to the right), press **#** with no letter currently selected. However, do not attempt to enter a "space" at the beginning of the line.

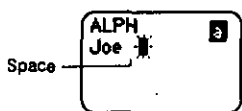

9. Repeat this process as many time as necessary until the desired Name Tag appears.

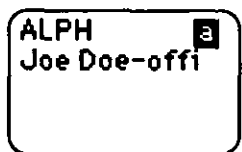

10. When you're done making the Name Tag entry, press **ALPH**.

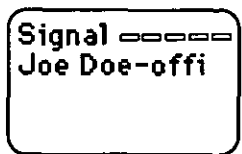

11. Using the numeric keypad, enter the corresponding phone number. In this example, we've used 2224444.

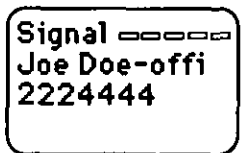

12. Press **STO**.

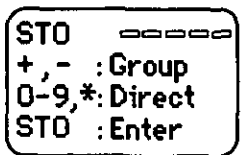

13. At this point to also store the number by memory location slot number, enter the desired two-digit Memory Location Number. Otherwise, press **STO**.

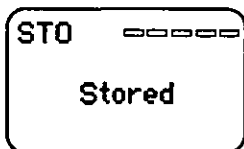

14. You have now successfully stored the Name Tag **Joe Doe-offi** with his corresponding office phone number.

15. Press **CLR** to return to the normal display.



16. Repeat steps 2 through 13 for the second Name Tag and number: **Joe Doe-home**, and corresponding home phone number.

17. Once you've completed entering these two Name Tags, press **CLR** to escape this mode and return to the normal display.

18. To verify correct storage, recall these Name Tags by pressing **RCL** **ALPH** **+** / **-**, or by Memory Location number (if applicable).

19. If you wish to make a call at this point, verify the correct display and press **SND**.

EXAMPLE #2 - Storing Existing Name Tags Underneath Group Label

Now that we have two phone numbers stored for Joe Doe, let's store these numbers underneath one larger Group Label called "FRIEND".

To create Group Label called "FRIEND":

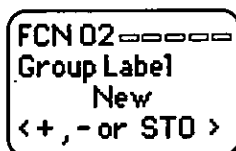

1. From the normal display, press **FCN** **MEMORY 0** **EDIT 2 ABC**.

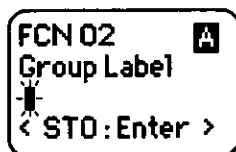

2. Press **STO** and observe the cursor appears on the display.
3. Enter the Group Label name using the Word List stored in your phone's memory by first verifying that the phone is in ALPH mode (input display mode character in upper right-hand corner).

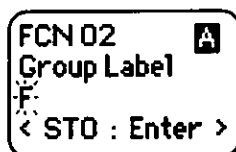

NOTE: Group Label can also be created using alpha input.

4. Use the **+** and **-** keys to scroll to the first letter of the desired word. For example, "F" when you wish to locate the word "FRIEND".
5. To select the initial letter, press any of the digits between **MEMORY 0** to **OPTION 9 WZY**.

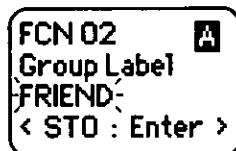

6. Scroll through the Word List using the **+** or **-** keys until the word "FRIEND" appears. (Alternatively at this point, you can directly press **OPTION 9 WZY** key; see Word list commands described on page 3-17).



FCN 02 0000
Group Label
FRIEND
Set

7. Press **(STO)** to save this Group Label name entry.

To apply the Joe Doe Name Tags created in Example 1 to the FRIEND Group Label:

RCL 0000
Joe Doe-offi
2224444

8. Recall the **Joe Doe-offi** Name Tag (press **(RCL)** **(ALPH)** **(+)** / **(-)**).

RCL Edit 
Name?
Joe Doe-offi

9. Since the Name Tag already exists, press **(STO)** and **(ALPH)** to enter Speed-Dial Memory Edit mode.
10. If no changes are necessary to Name?, press **(STO)** .

RCL Edit
Tel No?
2224444

11. If no changes are necessary for Tel No?, press **(STO)** .

RCL Edit
Group?
< + , - or STO >







12. For Group? press **(+)** / **(-)** keys to scroll to desired Group Label name—in this case FRIEND. When **FRIEND** appears, press **(STO)** .

RCL Edit
Group?
FRIEND
< + , - or STO >

RCL Edit
Direct No?
< digits , STO >

STO 
Stored

13. If no changes are necessary for Direct No?, press  .

14. Verify that **Joe Doe-offi** Name Tag is now stored underneath the Group Label **FRIEND** by pressing  
 /    /  (see page 3-31 for details).

15. Repeat steps 8-14 for second Name Tag **Joe Doe-home**.



Speed-Dial Memory Index

B

MEMORY LOCATION	NUMBER	NAME
01		
02		
03		
04		
05		
06		
07		
08		
09		
10		
11		
12		
13		
14		
15		
16		
17		
18		

MEMORY LOCATION	NUMBER	NAME
19		
20		
21		
22		
23		
24		
25		
26		
27		
28		
29		
30		
31		
32		
33		
34		
35		
36		
37		
38		
39		
40		
41		
42		
43		

MEMORY LOCATION	NUMBER	NAME
44		
45		
46		
47		
48		
49		
50		
51		
52		
53		
54		
55		
56		
57		
58		
59		
60		
61		
62		
63		
64		
65		
66		
67		
68		

MEMORY LOCATION	NUMBER	NAME
69		
70		
71		
72		
73		
74		
75		
76		
77		
78		
79		
80		
81		
82		
83		
84		
85		
86		
87		
88		
89		
90		
91		
92		
93		

MEMORY LOCATION	NUMBER	NAME
94		
95		
96		
97		
98		
99		

YOUR PHONE NUMBER (____) _____

INDEX

- (FCN 0) Memory (3-93)
- (FCN 1) Call Length Timer (3-52)
- (FCN 2) Battery (3-54)
- (FCN 3) Security (3-57)
- (FCN 4) Ringing (3-68)
- (FCN 5) Keytones (3-72)
- (FCN 6) Display (3-73)
- (FCN 7) System (3-76)
- (FCN 8) Clock (3-80)
- (FCN 9) Vehicle Use Options (3-89)

- A/B System Select (3-77)
- Accessories (1-5), (1-9)
- Alert (3-91)
 - to activate (3-91)
 - to use (3-92)
- Alphanumeric Input Mode (3-14)
 - entering letters/numbers (3-14)
 - input character list (3-15)
- Antenna
 - how to extend/retract (2-10)
- Auto Answer (3-71)
- Auto Memory Location (3-21)
- Auto Power Off (3-86)
- Auto Power On (3-84)
- Auto Retry (3-4)
- Automatic Recall (3-82)

- Backlight (3-74)
 - backlight control (3-74)
 - setting backlight color (3-75)
- Battery Level Indicator (3-54)
- Battery Pack (2-3)
 - charging procedures (2-5)
 - how to install/remove (2-4)
 - information (2-3)
 - low battery alarm (3-56)
 - standby time/talk time (2-3)

- Call Length Timer (FCN 1) (3-52)
- Call Receive (3-89)
 - to activate (3-89)
 - to use (3-90)
- Call-Back Number (3-46)
- Caller's Memory (3-38)
- Carrier (1-14)
 - home carrier (1-14)
- Carrying Strap (2-11)
- Charging
 - with travel charger (2-8)
- Cleaning (2-11)
- Clock
 - setting (3-80)
- Clock (FCN 8) (3-80)

- DC Adapter Kit EB-912 (1-6)
- Dial Lock (3-57)
- Dialing Digits Restriction (3-58)
- Dialing Digits Restriction (CELL Mode Only) (3-58)
- Display (FCN 6) (3-73)
- DTMF From Memory (3-38)
- DTMF Interval (3-12)
- Dual Tone Multi-Frequency (DTMF) (3-12)

- Enhanced Features (3-46)
 - call-back number (3-46)
 - short message (3-48)
 - voice mail (3-49)
- Escalating Ring Tone (3-70)

- FCN 9 (3-89)
- Features (1-2)
- Flash Request (3-13)
- Full Lock (3-57)
- Function Key Operation (3-44)

- Group Label (3-25)
 - creating/deleting (3-94)

- recalling by (3-31)
- storing by (3-25)
- Handset Kit HH950 (1-5)
- Handsfree/Car Mount Kit
 - EB-905 (1-7)
- Hold (3-11)
- Home System Only Mode
 - (3-79)
- In-Cabin Booster Kit (1-8)
- In-Cabin Booster Kit EB-910
 - (1-8)
- In-Trunk Booster Kit (1-8)
- In-Trunk Booster Kit EB-910A
 - (1-8)
- Indicator Tones (3-5)
 - intercept (3-5)
- Intercept Tones
 - re-order (3-5)
- Keys and Indicators (2-1)
- Keytones On/Off (FCN 5) (3-72)
- Last Number Memory (3-36)
- Lock (3-57)
 - lock setting (3-58)
 - theft (3-61)
- Lock Code (3-67)
 - how to set (3-67)
- Making a Call (3-3)
- Master Function (3-63)
 - clear (3-63)
 - default setting list (3-64)
 - reset (3-63)
 - set (3-63)
- Memory
 - caller's (3-38)
 - changing memory contents
 - (3-33)
 - check (3-93)
 - deleting memory contents
 - (3-35)
 - DTMF from (3-38)
 - last dial memory (3-36)
 - override protection (3-23)
 - scratch pad (3-37)
 - secret (3-60)
- Memory (FCN 0) (3-93)
- Memory Map (3-22)
- Memory Secret (3-60)
- Messages
 - All Occupied (3-21)
 - ALPH (3-17)
 - Already Occupied (3-21)
 - Dial Limit (3-59)
 - FCN*:Msgs (3-47), (3-48),
 - (3-50)
 - Good Afternoon! (3-73)
 - Good Morning! (3-73)
 - Hold (3-12)
 - In Use (3-3), (3-4), (3-9)
 - Last Timer (3-53)
 - Low Battery (3-56)
 - Mem Secret (3-60)
 - MUTE (3-9), (3-11)
 - No Service (3-2)
 - Non Occupied (3-29)
 - RCVD Call (3-7), (3-10)
 - Ring (3-6)
 - ROAM N (3-2), (3-77)
 - ROAM W (3-2), (3-78)
 - SIGNAL (3-2), (3-77)
 - Temporary (3-25), (3-32)
 - Theft Lock (3-61)
 - URGI (3-50)
 - User's Mem Full (3-21)
- Mute (3-11)
- N-W/L System (3-79)
- Name Tag (3-23)
 - recalling by (3-30)
 - storing by (3-23)
- NAMPS (1-14)
- Non-Wireline Carrier (N-W/L)
 - (1-14), (3-77)
- Normal Mode (3-78)
- Override Protection (3-23)

- Own Number Display (3-76)
- Pace Beep (3-55)
- Panasonic Service Center (1-12)
- Pause Dial (3-41)
 - to program and use (3-42)
- Powering Off (3-8)
- Powering On (3-1)
- Prefixed Dialing (3-39)
- Radio Mute Option (3-92)
- Rapid Charger Kit EB-911 (1-6)
- Recall (3-27)
 - by Group Label (3-31)
 - by Memory Location Number (3-28)
 - by Name Tag (3-30)
- Receive Lock (3-57)
- Received Call Indicator (3-10)
- Receiving a Call (3-6)
- Redial (3-4)
- Ring Tone (3-6), (3-69)
 - dual (3-69)
 - escalating (3-70)
 - setting (3-69)
 - special (3-69)
 - standard (3-69)
- Ringing (3-68)
 - ring volume control (3-68)
- Roaming (1-14)
 - Automatic Roaming (1-14)
 - Credit Card Roaming (1-14)
 - Follow-Me Roaming (1-14)
- Safety Timer (3-88)
- Scratch Pad Memory (3-37)
- Security (3-57)
- Send Lock (3-57)
- Short Message (3-48)
- Signal strength (3-2)
- Speed-Dial Memory (3-19)
 - edit (3-33)
 - how to edit (3-33)
- Standby Time (2-3)
 - auto memory location (3-21)
 - by Group Label (3-25)
 - by Name Tag (3-23)
 - storing by memory location number (3-20)
- Standby Time/Talk Time (2-3)
- Store (3-19)
 - by Group Label (3-25)
 - by Name Tag (3-23)
 - storing by memory location number (3-20)
- Super-Speed Dialing (3-29)
- System (FCN 7) (3-76)
- Talk Time (2-3)
- Theft Code (3-66)
 - how to set (3-66)
- Theft Lock (3-61)
- Timers
 - Last Timer (3-52)
 - Num 1 Timer (3-52)
 - Num 2 Timer (3-52)
 - safety (3-88)
 - Total Timer 1 (3-52)
 - Total Timer 2 (3-52)
- Unlock (3-57)
- Vehicle Use Options (3-89)
- Vehicle Use Options (FCN 9) (3-89)
- Voice Mail (3-49)
- Volume
 - earpiece/keytone (3-9)
- W/L System Only Mode (3-79)
- Wake-up Display
 - program (3-73)
- Wake-up display message (3-1)
- Wireline Carrier (W/L) (1-14), (3-77)
- Word List (3-17), (3-18)

ACCESSORY ORDER FORM FOR Panasonic CELLULAR PHONE

1 PHONE MODEL # HH950

2 ITEMS ORDERED

ACCES #	DESCRIPTION	\$ EACH	QTY	TOTAL
EB-905	SIMPLE CAR MOUNT KIT INCLUDES THE FOLLOWING HANDSFREE UNIT/RAPID CHARGER (EB-J10139), ADJUSTABLE ANGLE BRACKET (EB-N0001C), MICROPHONE (EB-M1177), POWER SUPPLY CABLE (EB-W10030)	CALL		
EB-910	IN-CABIN BOOSTER KIT INCLUDES THE FOLLOWING 3 WATT BOOSTER (EB-U10022) PROVIDES 3 WATTS OF POWER AND CAN BE INSTALLED IN THE PASSENGER SECTION OF THE VEHICLE	CALL		
EB-910A	IN-TRUNK BOOSTER KIT INCLUDES THE FOLLOWING 3 WATT BOOSTER (EB-U10022), EXT RF CABLE (17')(EB-W10035), EXT POWER SUPPLY CABLE (17')(EB-W10036), EXT INTERCONNECTING CABLE (17')(EB-W10034)	CALL		
EB-911	RAPID CHARGER KIT INCLUDES THE FOLLOWING RAPID CHARGER (EB-P10151) CHARGES THE BATTERY IN AN HOUR	CALL		
EB-912	DC ADAPTOR KIT INCLUDES THE FOLLOWING DC ADAPTOR (EB-P10152), CRADLE (EB-J10138) AND ADJUSTABLE ANGLE BRACKET (EB-N0001C)	CALL		
EB-P10180	NICKEL METAL HYDRIDE BATTERY PACK (500mAh) — PROVIDES APPROX 80 MINUTES OF CONTINUOUS TALK TIME AND 12 HOURS OF STAND-BY OPERATION	CALL		
EB-P10149	NICKEL CADMIUM BATTERY (900mAh) — PROVIDES APPROX 160 MINUTES OF CONTINUOUS TALK TIME AND 24 HOURS OF STAND-BY OPERATION	CALL		
EB-P10150	TRAVEL CHARGER — CHARGES THE BATTERY IN 10 HOURS	CALL		
EB-W10033A	EXT POWER SUPPLY CABLE (12') — CONNECTS THE 3W BOOSTER TO THE POWER SUPPLY CABLE FOR THE BOOSTER INSTALLATION IN TRUNK	CALL		
EB-W10036A	EXT POWER SUPPLY CABLE (17') — CONNECTS THE 3W BOOSTER TO THE POWER SUPPLY CABLE FOR THE BOOSTER INSTALLATION IN TRUNK	CALL		
EB-W10034A	EXT INTER CONNECTING CABLE (17') — CONNECTS THE 3W BOOSTER TO THE HANDSFREE CRADLE FOR THE BOOSTER INSTALLATION IN TRUNK	CALL		
EB-W10035A	EXT RF CABLE — CONNECTS THE 3W BOOSTER TO THE HANDSFREE CRADLE FOR THE BOOSTER INSTALLATION IN TRUNK	CALL		
EB-J10262	ALERT UNIT — WITH THE IGNITION OFF THE HORN WILL SOUND OR YOUR VEHICLE'S LIGHTS WILL BLINK WHEN YOU RECEIVE A CALL	CALL		

YOUR STATE & LOCAL TAX

SHIPPING & HANDLING

TOTAL ENCLOSED

\$ 5 00

HAVE MODEL # READY BEFORE YOU CALL !!!

3. Method of Payment (check one)

Check or Money Order enclosed (no C.O.D. shipments)

Visa Mastercard Discover

Credit Card # _____

Expiration Date _____

Customer Signature _____

Send check or Money Order To: Matsushita Services Company
Accessory Sales Dept, Box 101
(please do not send cash) 545 Tollgate Rd., Suite C
Elgin, IL 60123

4. Shipping information:

(UPS delivery requires complete street address)

No PO Box # PLEASE.

Ship To:

Mr.

Mrs.

Ms. _____

First

Last

Middle

Street Address _____

Phone #

Day () _____

City _____

State _____

Zip _____

Night () _____

To obtain any of our Accessories, please call:

PANASONIC ACCESSORY ORDER LINE 1-800-382-3709

CENTRAL TIME

(for orders only)

BUSINESS HOURS:

MONDAY — THURSDAY

8 AM — 7:30 PM

FRIDAY

8 AM — 5:00 PM

SATURDAY

9 AM — 12:30 PM

NOTE: 1) Prices subject to change without notice.
2) Accessories may be discontinued without notice.

Panasonic Communications and Systems Company
Division of Matsushita Electric Corporation of America
Two Panasonic Way, Secaucus, New Jersey 07094